

**Contact SAMSUNG WORLDWIDE**

If you have any questions or comments relating to Samsung products, please contact the SAMSUNG customer care centre.

Country	Customer Care Centre ☎	Web Site
AUSTRIA	0800-SAMSUNG (726-7864)	www.samsung.com/at
BELGIUM	0032 (0)2 201 24 18 844 000 844	www.samsung.com/be www.samsung.com/cz
CZECH REPUBLIC	Distributor pro Českou republiku: Samsung Zrt., česká organizační složka Vyskočilova 4, 14000 Praha 4	
DENMARK	70 70 19 70	www.samsung.com/dk
EIRE	0818 717 100	www.samsung.com/ie
FINLAND	030-6227 515	www.samsung.com/fi
FRANCE	3260 SAMSUNG (€ 0,15/Min) 08 25 08 65 65 (€ 0,15/Min)	www.samsung.com
GERMANY	01805 - SAMSUNG (726-7864) (€ 0,14/Min)	www.samsung.com
HUNGARY	06-80-SAMSUNG (726-7864)	www.samsung.com
ITALIA	800-SAMSUNG (726-7864)	www.samsung.com
LUXEMBURG	0035 (0)2 261 03 710	www.samsung.com/be
NETHERLANDS	0900-SAMSUNG (726-7864) (€ 0,10/Min)	www.samsung.com/nl
NORWAY	815-56 480	www.samsung.com/no
POLAND	0 801 801 881 022-607-93-33	www.samsung.com/pl
PORTUGAL	80820-SAMSUNG (726-7864)	www.samsung.com/pt
SLOVAKIA	0800-SAMSUNG (726-7864)	www.samsung.com/sk
SPAIN	902 10 11 30	www.samsung.com
SWEDEN	0771-400 200	www.samsung.com/se
SWITZERLAND	0800-SAMSUNG (726-7864)	www.samsung.com/ch
U.K	0845 SAMSUNG (7267864)	www.samsung.com
TURKEY	444 77 11	www.samsung.com
ESTONIA	800-7267	www.samsung.ee
LATVIA	800-7267	www.samsung.com/lv
LITHUANIA	8-800-77777	www.samsung.lt
KAZAHSTAN	8-10-800-500-55-500	www.samsung.kz
KYRGYZSTAN	00-800-500-55-500	-
RUSSIA	8-800-555-55-55	www.samsung.ru
TADJIKISTAN	8-10-800-500-55-500	-
UKRAINE	8-800-502-0000	www.samsung.com
UZBEKISTAN	8-10-800-500-55-500	www.samsung.uz



BN68-01424P-00

SERIES  
4

# LCD TV

## user manual

imagine the possibilities

Thank you for purchasing this Samsung product.  
To receive more complete service, please register  
your product at

[www.samsung.com/global/register](http://www.samsung.com/global/register)

Model \_\_\_\_\_ Serial No. \_\_\_\_\_



### Contact SAMSUNG WORLDWIDE

If you have any questions or comments relating to Samsung products, please contact the SAMSUNG customer care centre.(See back cover for more information)

### Precautions When Displaying a Still Image

A still image may cause permanent damage to the TV screen.

- Do not display a still image on the LCD panel for more than 2 hours as it can cause screen image retention.

This image retention is also known as "screen burn".

To avoid such image retention, reduce the degree of brightness and contrast of the screen when displaying a still image.

-  Watching the LCD TV in 4:3 format for a long period of time may leave traces of borders displayed on the left, right and center of the screen caused by the difference of light emission on the screen. Playing a DVD or a game console may cause a similar effect to the screen. Damages caused by the above effect are not covered by the Warranty.
- Displaying still images from Video games and PC for longer than a certain period of time may produce partial after-images.  
To prevent this effect, reduce the 'brightness' and 'contrast' when displaying still images.

# Contents

## CONNECTING AND PREPARING YOUR TV

◆ List of Parts .....	2
◆ Installing the Stand.....	2
◆ Installing the Wall Mount Kit .....	2
◆ Viewing the Control Panel.....	3
◆ Viewing the Connection Panel .....	4
◆ Viewing the Remote Control.....	6
◆ Installing Batteries in the Remote Control .....	7
◆ Switching On and Off .....	7
◆ Placing Your Television in Standby Mode.....	7
◆ Viewing the Menus.....	8
◆ Using the TOOLS Button.....	8
◆ Plug & Play.....	9

## SETTING THE CHANNELS

◆ Storing Channels Automatically .....	10
◆ Storing Channels Manually .....	11
◆ Adding / Locking Channels .....	12
◆ Sorting the Stored Channels .....	13
◆ Assigning Channels Names .....	13
◆ Fine Tuning Channel Reception.....	14
◆ LNA (Low Noise Amplifier) .....	14

## SETTING THE PICTURE

◆ Changing the Picture Standard .....	15
◆ Adjusting the Custom Picture.....	16
◆ Resetting the Picture Settings to the Factory Defaults .....	16
◆ Changing the Picture Options .....	17

## SETTING THE SOUND

◆ Sound Features.....	19
◆ Selecting the Sound Mode.....	20
◆ Connecting Headphones (Sold separately) .....	20

## SETTING THE TIME

◆ Setting and Displaying the Current Time.....	21
◆ Setting the Sleep Timer.....	21
◆ Switching the Television On and Off Automatically.....	22

## FUNCTION DESCRIPTION

◆ Choosing Your Language.....	22
◆ Melody / Energy Saving .....	23
◆ Selecting the Source.....	24
◆ Editing the Input Source Names .....	24

## USING THE DTV FEATURE

◆ Previewing the DTV Menu System .....	25
◆ Updating the Channel List Automatically.....	26
◆ Updating the Channel List Manually .....	26
◆ Editing Your Favourite Channels .....	27
◆ Selecting Channel List .....	29
◆ Displaying Programme Information.....	29
◆ Viewing the EPG (Electronic Programme Guide) Information .....	30
◆ Using the Scheduled List .....	31
◆ Setting the Default Guide .....	31
◆ Viewing All Channels and Favourite Channels .....	32
◆ Adjusting the Menu Transparency.....	32
◆ Setting up the Parental Lock .....	33
◆ Setting the Subtitle .....	34
◆ Setting the Subtitle Mode .....	34
◆ Selecting the Audio Format .....	34
◆ Selecting the Audio Description .....	35
◆ Selecting the Digital Text (UK only).....	35
◆ Selecting the Time Zone (Spain only) .....	36
◆ Viewing Product Information .....	36
◆ Checking the Signal Information .....	37
◆ Upgrading the Software .....	37
◆ Viewing Common Interface .....	38
◆ Selecting the CI (Common Interface) Menu.....	38
◆ Resetting .....	39
◆ Selecting the Preferred Language (Subtitle, Audio or Teletext) .....	39
◆ Preference.....	40

## SETTING THE PC

◆ Setting up Your PC Software (Based on Windows XP) .....	41
◆ Display Modes.....	41
◆ Setting up the TV with your PC .....	42

## RECOMMENDATIONS FOR USE

◆ Teletext Feature .....	43
◆ Using the Anti-Theft KENSINGTON LOCK (depending on the model).....	44
◆ Securing the TV to the Wall.....	45
◆ Troubleshooting: Before Contacting Service Personnel .....	46
◆ Technical and Environmental Specifications .....	47



## List of Parts

Please make sure the following items are included with your LCD TV.  
If any items are missing, contact your dealer.



Remote Control &  
Batteries (AAA x 2)



Power Cord

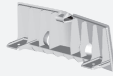

Cover-Bottom



M4XL16

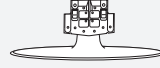

Stand



Cleaning Cloth

◆ Owner's Instructions

◆ Warranty card

◆ Safety Guide

◆ Registration Cards

- Warranty card / Safety Guide / Registration Cards (Not available in all locations)
- The stand and stand screw may not be included depending on the model.

## Installing the Stand

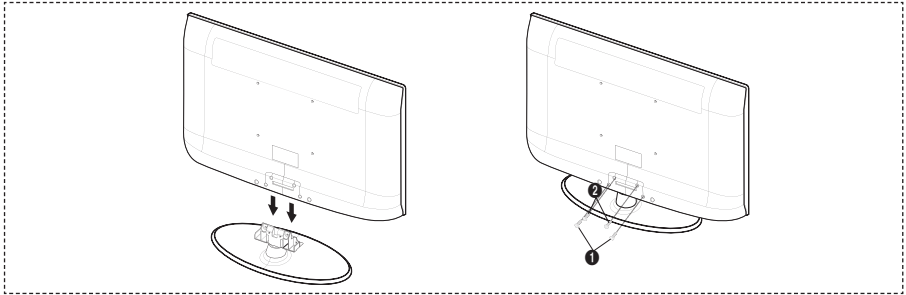

1. Connect your LCD TV and the stand.
  - Two or more people should carry the TV.
  - Make sure to distinguish between the front and back of the stand when assembling them.
2. Fasten two screws at position ① and then fasten two screw at position ②.
  - Stand the product up and fasten the screws. If you fasten the screws with the LCD TV placed down, it may lean to one side.
  - The stand is installed for models with the screen size of 37 inch and above.

## Installing the Wall Mount Kit

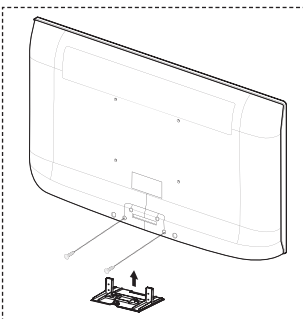

Wall mount items (sold separately) allow you to mount the TV on the wall.

For detailed information on installing the wall mount, see the instructions provided with the Wall Mount items. Contact a technician for assistance when installing the wall mounted bracket. Samsung Electronics is not responsible for any damage to the product or injury to yourself or others if you elect to install the TV on your own.





Do not install your Wall Mount Kit while your TV is turned on. It may result in personal injury due to electric shock.

- Remove the stand and cover the bottom hole with a cap and fasten with two screws.

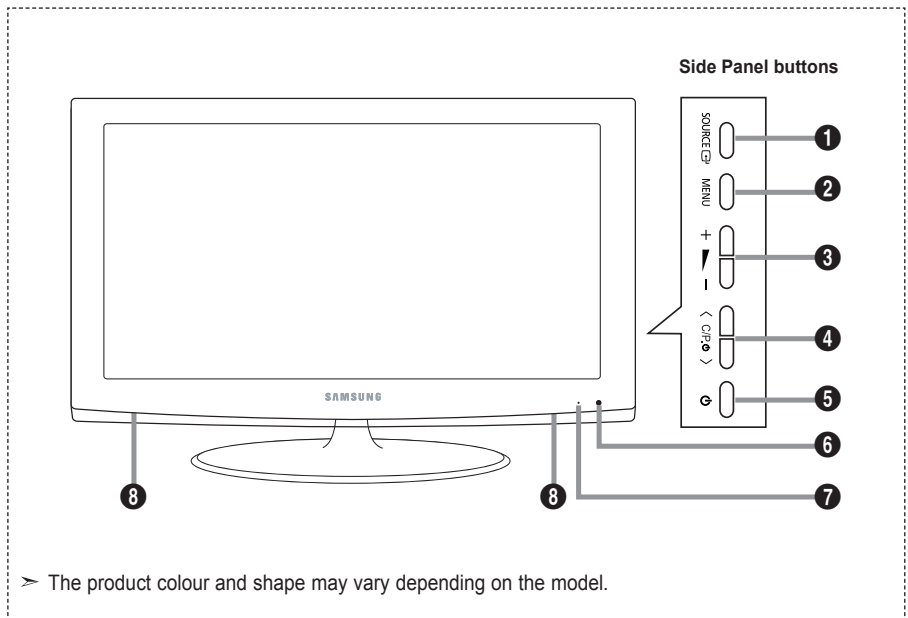
## Viewing the Control Panel



➤ The product colour and shape may vary depending on the model.

- 1 SOURCE**  Toggles between all the available input sources (TV, Ext., AV, Component, PC, HDMI, DTV). In the on-screen menu, use this button as you use the **ENTER**  button on the remote control.
- 2 MENU** Press to see an on-screen menu of your TV's features.
- 3 + ▸ -** Press to decrease or increase the volume. In the on-screen menu, use the + ▸ - buttons as you use the ◀ and ▶ buttons on the remote control.
- 4 < C/P>** Press to change channels. In the on-screen menu, use the < C/P> buttons as you use the ▲ and ▼ buttons on the remote control. (Without the Remote Control, you can turn on the TV by using the Channel buttons.)
- 5 ⏻ (Power)** Press to turn the TV on and off.
- 6 Remote Control Sensor** Aim the remote control towards this spot on the TV.
- 7 Power Indicator** Blinks and turns off when the power is on and lights up in stand-by mode.
- 8 Speakers**

# Viewing the Connection Panel

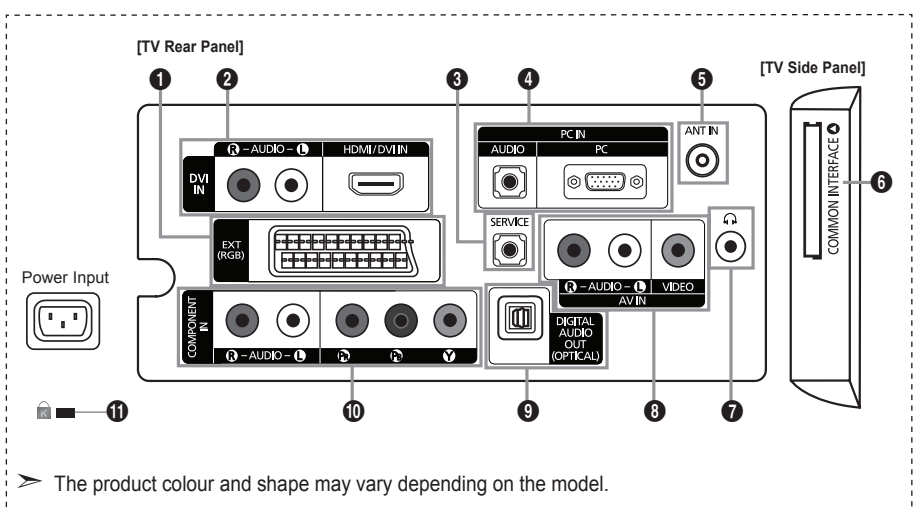

➤ The product colour and shape may vary depending on the model.

- Whenever you connect an external device to your TV, make sure that power on the unit is turned off.
- When connecting an external device, match the colour of the connection terminal to the cable.

## 1 EXT

Connector	Input			Output	
	Video	Audio (L/R)	RGB	Video + Audio (L/R)	
EXT	0	0	0	Only TV or DTV output is available.	

-Inputs or outputs for external devices, such as VCR, DVD, video game device or video disc players.

## 2 DVI IN [HDMI/DVI IN]

- Supports connections between HDMI-connection-enabled AV devices (Set-Top Boxes, DVD players)
- No additional Audio connection is needed for an HDMI to HDMI connection.

### ➤ What is HDMI?

- "High Definition Multimedia interface" allows the transmission of high definition digital video data and multiple channels of digital audio.
- The HDMI/DVI terminal supports DVI connection to an extended device with the appropriate cable (not supplied). The difference between HDMI and DVI is that the HDMI device is smaller in size, has the HDCP (High Bandwidth Digital Copy Protection) coding feature installed, and supports multi-channel digital audio.

## DVI IN [R-AUDIO-L]

- DVI audio outputs for external devices.
- Supported modes for HDMI/DVI and Component

	480i	480p	576i	576p	720p	1080i
HDMI/DVI 50Hz	X	X	X	O	O	O
HDMI/DVI 60Hz	X	O	X	X	O	O
Component	O	O	O	O	O	O

## 3 SERVICE

- Connector for SERVICE only.

## 4 PC IN [PC] / [AUDIO]

- Connect to the video and audio output jack on your PC.

## 5 ANT IN

To view television channels correctly, a signal must be received by the set from one of the following sources:

- An outdoor aerial / A cable television network / A satellite network

## 6 COMMON INTERFACE Slot

- When CI Card isn't inserted in some channels, "Scrambled Signal" is displayed on the screen.
- The pairing information containing a telephone number, CI Card ID, Host ID and other information will be displayed in about 2~3 minutes. If an error message is displayed, please contact your service provider.
- When the channel information configuration has finished, the message "Updating Completed" is displayed, indicating that the channel list is now updated.

- You must obtain a CI Card from a local cable service provider. Remove the CI Card by carefully pulling it out with your hands since dropping the CI Card may cause damage to it.
- Insert the CI-Card in the direction marked on it.
- The place of the COMMON INTERFACE Slot may be different depending on its model.

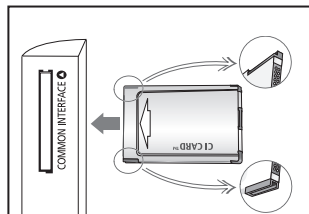

## 7 Headphones jack

- Headphone may be connected to the headphone output on your set. While the head phone is connected, the sound from the built-in speakers will be disabled.

## 8 AV IN [VIDEO]/[R-AUDIO-L]

- Connect RCA cable to an appropriate external A/V device such as VCR, DVD or Camcorder.
- Connect RCA audio cables to [R-AUDIO-L] on your set and the other ends to corresponding audio out connectors on the A/V device.

## 9 DIGITAL AUDIO OUT (OPTICAL)

- Connect to a Digital Audio Component.
- When the HDMI IN jacks are connected, the DIGITAL AUDIO OUT (OPTICAL) jack on the TV outputs 2 channel audio only. If you want to hear 5.1 channel audio, connect the Optical jack on the DVD player or Cable/Satellite Box directly to an Amplifier or Home Theater, not the TV.

## 10 COMPONENT IN

- Connect component video cables (optional) to component connector ("P<sub>R</sub>", "P<sub>B</sub>", "Y") on the rear of your set and the other ends to corresponding component video out connectors on the DTV or DVD.
- If you wish to connect both the Set-Top Box and DTV (or DVD), you should connect the Set-Top Box to the DTV (or DVD) and connect the DTV (or DVD) to component connector ("P<sub>R</sub>", "P<sub>B</sub>", "Y") on your set.
- The P<sub>R</sub>, P<sub>B</sub> and Y connectors on your component devices (DTV or DVD) are sometimes labeled Y, B-Y and R-Y or Y, Cb and Cr.
- Connect RCA audio cables (optional) to [R - AUDIO - L] on the rear of your set and the other ends to corresponding audio out connectors on the DTV or DVD.

## 11 KENSINGTON LOCK (depending on the model)

- The Kensington lock (optional) is a device used to physically fix the system when used in a public place.
- If you want to use a locking device, contact the dealer where you purchased the TV.
- The location of the kensington lock may be different depending on its model.

# Viewing the Remote Control

- 1 Television Standby button
- 2 Selects the TV and DTV mode directly
- 3 Number buttons for direct channel access
- 4 One/Two-digit channel selection
- 5 ⊕: Volume increase  
⊖: Volume decrease
- 6 Temporary sound switch-off
- 7 Use to quickly select frequently used functions.
- 8 Use to see information on the current broadcast
- 9 Colour buttons :  
Use these buttons in the Channel list, etc.
- 11 Electronic Program Guide (EPG) display
- 12 Available source selection
- 13 Previous channel
- 14 P⊙: Next channel  
P⊙: Previous channel
- 15 Returns to the previous menu
- 16 Control the cursor in the menu
- 17 Exit the on-screen menu
- 18 Picture size selection
- 19 Displays the main on-screen menu
- 20 Displays the Channel List on screen
- 21 Digital subtitle display

## Teletext Functions

- 2 Exit from the teletext display
- 7 Teletext size selection
- 8 Teletext reveal
- 9 Fastext topic selection
- 10 Alternately select Teletext, Double, or Mix.
- 11 Teletext store
- 12 Teletext mode selection (LIST/FLOF)
- 13 Teletext sub page
- 14 P⊙: Teletext next page  
P⊙: Teletext previous page
- 15 Teletext hold
- 17 Teletext cancel
- 19 Teletext index

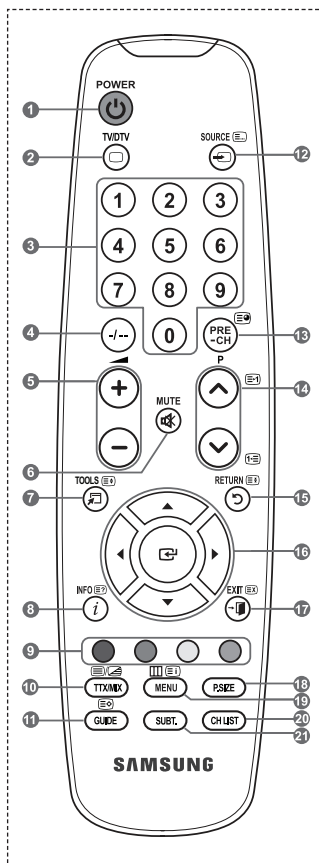

➤ The performance of the remote control may be affected by bright light.



## Installing Batteries in the Remote Control

1. Lift the cover at the back of the remote control upward as shown in the figure.
2. Install two AAA size batteries.
  - Make sure to match the "+" and "-" ends of the batteries with the diagram inside the compartment.
3. Replace the cover.
  - Remove the batteries and store them in a cool, dry place if you won't be using the remote control for a long time.

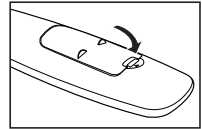
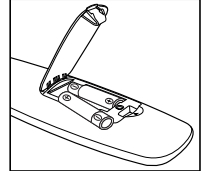
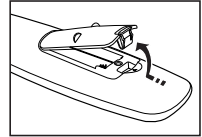

- 
- If the remote control doesn't work, check the following:
1. Is the TV power on?
  2. Are the plus and minus ends of the batteries reversed?
  3. Are the batteries drained?
  4. Is there a power outage, or is the power cord unplugged?
  5. Is there a special fluorescent light or neon sign nearby?
- 

## Switching On and Off

The mains lead is attached to the rear of your set.

1. Plug the mains lead into an appropriate socket.
  - The standby indicator lights up on your set.
2. Press the  $\phi$  button on your set.
  - You also can press the **POWER**  $\phi$  button or the **TV/DTV** button on the remote control to turn the TV on.
  - The channel that you were watching last is reselected automatically.
3. Press the numeric button (0~9) or channel up/down ( $\odot/\ominus$ ) button on the remote control or **< C/P.  $\phi$  >** button on your set.
  - When you switch the set on for the very first time, you will be asked to choose language in which the menus are to be displayed.
4. To switch your set off, press the **POWER**  $\phi$  button again.

## Placing Your Television in Standby Mode

Your set can be placed in standby mode in order to reduce the power consumption. The standby mode can be useful when you wish to interrupt viewing temporarily (during a meal, for example).

1. Press the **POWER**  $\phi$  button on the remote control.
  - The screen is turned off and a red standby indicator appears on your set.
2. To switch your set back on, simply press the **POWER**  $\phi$ , numeric buttons (0~9), **TV/DTV** button or channel up/down ( $\odot/\ominus$ ) button again.
  - Do not leave your set in standby mode for long periods of time (when you are away on holiday, for example).  
It is best to unplug the set from the mains and aerial.

## Viewing the Menu

1. With the power on, press the **MENU** button.  
The main menu appears on the screen. The menu's left side has icons: Picture, Sound, Channel, Setup, Input, Digital Menu.
2. Press the **▲** or **▼** button to select one of the icons.  
Then press the **ENTER** button to access the icon's sub-menu.
3. Press the **EXIT** button to exit.
  - The on-screen menu disappear from the screen after about one minute.

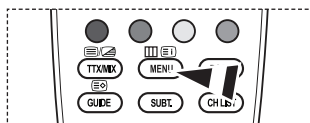
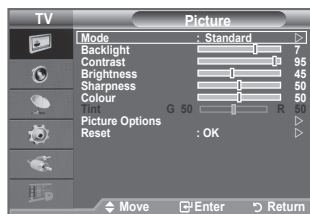

## Using the TOOLS Button

You can use the **TOOLS** button to select your frequently used functions quickly and easily. The "Tools" menu change depending on which external input mode you are viewing.

1. Press the **TOOLS** button.  
The "Tools" menu will appear.
2. Press the **▲** or **▼** button to select a menu.
3. Press the **▲/▼/◀/▶/ENTER** buttons to display, change, or use the selected items. For a more detailed description of each function, refer to the corresponding page.

- Picture Mode, see page 15
- Sound Mode, see page 19
- Sleep Timer, see page 21
- SRS TS XT, see page 19
- Energy Saving, see page 23
- Dual I-II, see page 20
- Auto Adjustment, see page 42

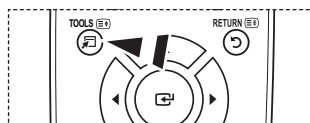
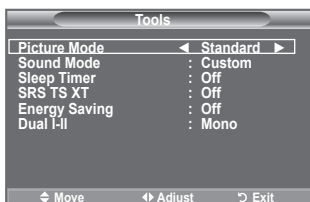

## Plug & Play

When the TV is initially powered on, several basic settings proceed automatically and subsequently. The following settings are available.

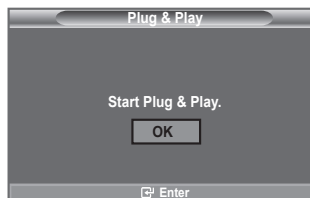

- Any functions related to Digital TV (DVB) will only work in countries or areas where DVB-T (MPEG2) digital terrestrial signals are broadcasted. Please confirm with your local dealer if you can receive DVB-T signals. Although this TV set follows the DVB-T specification, maintaining compatibility with the future coming DVB-T digital terrestrial broadcasts is not guaranteed. Several functions may not be available in some countries.
1. Press the **POWER** button on the remote control.  
The message "Start Plug & Play." is displayed with "OK" selected.
  2. Select the appropriate language by pressing the **▲** or **▼** button.  
Press the **ENTER** button to confirm your choice.
  3. Press the **◀** or **▶** button to select "Store Demo" or "Home Use", then the **ENTER** button.
    - We recommend setting the TV to "Home Use" mode for the best picture in your home environment.
    - "Store Demo" mode is only intended for use in retail environments.
    - If the unit is accidentally set to "Store Demo" mode and you want to return to "Home Use" (Standard): Press the Volume button on the TV. When the volume OSD is displayed, press and hold the **MENU** button on the TV for 5 seconds
  4. The message "Check antenna input." is displayed with "OK" selected.  
Press the **ENTER** button.
    - Please check that the antenna cable is connected correctly.
  5. Select the appropriate country by pressing the **▲** or **▼** button.  
Press the **ENTER** button to confirm your choice.
  6. The message "Some DTV functions may not be available. Digital Scan?" is displayed.  
Press the **◀** or **▶** button to select "Yes" or "No", then press the **ENTER** button.

- ♦ **Yes:** First an Analogue TV search is performed and then a Digital TV ch. auto search is performed.
    - ♦ **No:** Only an Analogue TV search is performed.

    - This function is supported for all countries except for the following countries: France, Germany, Italy, Netherlands, Spain, Switzerland, United Kingdom, Austria.
  7. The "Auto Store" menu is displayed with the "Start" selected. Press the **ENTER** button.
    - The channel search will start and end automatically.
    - The DTV channel scan menu appears and the DTV channel is automatically updated.
    - If the DTV channel is updated, the Source in the source list of the Input menu is automatically changed to DTV.
    - After all the available channels are stored, the "Clock Set" menu appears.
    - Press the **ENTER** button at any time to interrupt the memorization process.
    - For detailed descriptions about DTV channel update, refer to page 26 of this manual.
    - After all the available digital channels are stored, the screen to select a time zone is displayed depending on the country.
  8. Press the **ENTER** button.  
Select the "Month", "Day", "Year", "Hour", or "Min" by pressing the **◀** or **▶** button.  
Set the "Month", "Day", "Year", "Hour", or "Min" by pressing the **▲** or **▼** button.
    - You can also set the "Month", "Day", "Year", "Hour" and "Min" by pressing the number buttons on the remote control.

- Press the **ENTER** button to confirm your setting. The message "Enjoy your viewing" is displayed. When you have finished, press the **ENTER** button.
  - Even if the **ENTER** button is not pressed, the message will automatically disappear after several seconds.

- Language:** Select your language.
- Country:** Select your country.
- Auto Store:** Automatically scans for and stores channels available in the local area.
- Clock Set:** Sets the current time for the TV clock.

#### If you want to reset this feature...

- Press the **MENU** button to display the menu. Press the **▲** or **▼** button to select "Setup" then press the **ENTER** button.
- Press the **ENTER** button again, to select "Plug & Play". For further details on setting up options, refer to the page 9.
  - The "Plug & Play" feature is only available in the TV mode.



## Storing Channels Automatically

You can scan for the frequency ranges available to you (and availability depends on your country). Automatically allocated programme numbers may not correspond to actual or desired programme numbers. However, you can sort numbers manually and clear any channels you do not wish to watch.

- Press the **MENU** button to display the menu. Press the **▲** or **▼** button to select "Channel", then press the **ENTER** button.
- Press the **ENTER** button to select "Country".
- Select the appropriate country by pressing the **▲** or **▼** button. Press the **ENTER** button to confirm your choice.
  - Even though you have changed the country setting in this menu, the country setting for DTV is not changed. (Refer to page 26)
- Press the **▲** or **▼** button to select "Auto Store", then press the **ENTER** button.
- Press the **ENTER** button.
  - The TV will begin memorizing all of the available channels.
  - Press the **ENTER** button at any time to interrupt the memorization process and return to the "Channel" menu.
- After all the available channels are stored, the "Sort" menu appears. (refer to page 13)



## Storing Channels Manually

➤ Not available in DTV or external input mode.

**You can store television channels, including those received via cable networks.**

**When storing channels manually, you can choose:**

- ◆ Whether or not to store each of the channels found.
- ◆ The programme number of each stored channel which you wish to identify.

1. Press the **MENU** button to display the menu.  
Press the **▲** or **▼** button to select "Channel", then press the **ENTER** button.
2. Press the **▲** or **▼** button to select "Manual Store", then press the **ENTER** button.
3. Select the required option by pressing the **▲** or **▼** button, then press the **ENTER** button.
4. When you are satisfied with your setting, press the **ENTER** button.
5. Press the **EXIT** button to exit.

- ◆ **Programme** (Programme number to be assigned to a channel)
  - Press the **▲** or **▼** button until you find the correct number.
  - You can also select the channel number directly by pressing the numeric buttons (0~9).
- ◆ **Colour System: Auto/PAL/SECAM/NTSC4.43**
  - Press the **▲** or **▼** button to select the required colour standard.
- ◆ **Sound System: BG/DK/I/L**
  - Press the **▲** or **▼** button to select the required sound standard.
- ◆ **Channel** (When you know the number of the channel to be stored)
  - Press the **▲** or **▼** button to select **C** (Air channel) or **S** (Cable channel).
  - Press the **▶** button, then press the **▲** or **▼** button to select the required number.
  - You can also select the channel number directly by pressing the numeric buttons (0~9).
  - If there is abnormal sound or no sound, re-select the sound standard required.
- ◆ **Search** (When you do not know the channel numbers)
  - Press the **▲** or **▼** button to start the search.
  - The tuner scans the frequency range until the first channel or the channel that you selected is received on the screen.
- ◆ **Store** (When you store the channel and associated programme number)
  - Set to "OK" by pressing the **ENTER** button.
- **Channel mode**
  - **P** (Programme mode): When completing tuning, the broadcasting stations in your area have been assigned to position numbers from P00 to P99. You can select a channel by entering the position number in this mode.
  - **C** (Air channel mode): You can select a channel by entering the assigned number to each air broadcasting station in this mode.
  - **S** (Cable channel mode): You can select a channel by entering the assigned number for each cable channel in this mode.

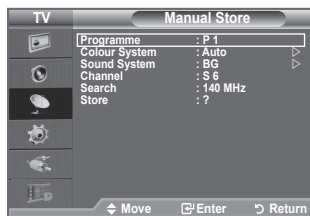

## Adding / Locking Channels

➤ Not available in DTV or external input mode.

**Using the Channel Manager, you can conveniently lock or add channels.**

1. Press the **MENU** button to display the menu.  
Press the **▲** or **▼** button to select "Channel", then press the **ENTER** button.
2. Press the **▲** or **▼** button to select "Channel Manager", then press the **ENTER** button.

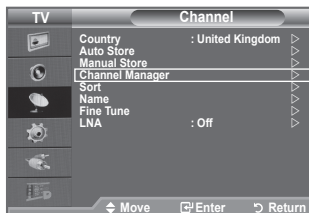

### ◆ Adding channels

Using the Channel List, you can add channels.

3. Select "Channel List" by pressing the **ENTER** button.
4. Move to the (⊕) field by pressing the **▲**, **▼**, **◀** or **▶** button, select a channel to be added, and press the **ENTER** button to add the channel.
  - If you press the **ENTER** button again, the (✓) symbol next to the channel disappears and the channel is not added.
  - "🔒" is active when "Child Lock" is selected to "On".



### ◆ Locking channels

This feature allows you to prevent unauthorized users, such as children, from watching unsuitable programmes by muting out video and audio.

5. Press the **▲** or **▼** button to select "Child Lock", then press the **ENTER** button.
6. Select "On" by pressing the **▲** or **▼** button, then press the **ENTER** button.
7. Press the **▲** or **▼** button to select "Channel List", then press the **ENTER** button.
8. Move to the "🔒" field by pressing the **▲**, **▼**, **◀** or **▶** button, select a channel to be locked, and press the **ENTER** button.
  - If you press the **ENTER** button again, the (✓) symbol next to the channel disappears and the channel lock is cancelled.
  - A blue screen is displayed when "Child Lock" is activated.
9. Press the **EXIT** button to exit.
  - Select "On" or "Off" in "Child Lock" to easily turn the channels which selected on "🔒" to be active or inactive.

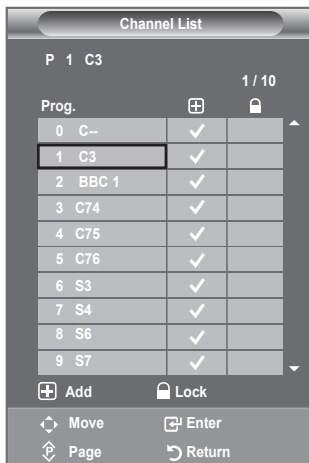

 You can select these options by simply pressing the **CH LIST** button on the remote control.

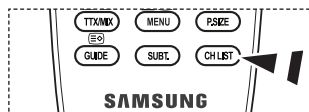

## Sorting the Stored Channels

This operation allows you to change the programme numbers of the stored channels.

This operation may be necessary after using the auto store.

➤ Not available in DTV or external input mode.

1. Press the **MENU** button to display the menu. Press the **▲** or **▼** button to select "Channel", then press the **ENTER** button.
2. Press the **▲** or **▼** button to select "Sort", then press the **ENTER** button.
3. Select the channel number that you wish to change by pressing the **▲** or **▼** button. Press the **ENTER** button.
  - The selected channel number and name are moved to right side.
4. Select the number of the programme to which the channel is to be moved by pressing the **▲** or **▼** button.
5. Press the **ENTER** button. The channel is moved to its new position and all other channels are shifted accordingly.
6. Repeat steps 3 to 5 for another channel to be sorted.
7. Press the **EXIT** button to exit.



## Assigning Channels Names

Channel names will be assigned automatically when channel information is broadcast. These names can be changed, allowing you to assign new names.

➤ Not available in DTV or external input mode.

1. Press the **MENU** button to display the menu. Press the **▲** or **▼** button to select "Channel", then press the **ENTER** button.
2. Press the **▲** or **▼** button to select "Name", then press the **ENTER** button.
3. If necessary, select the channel to be assigned to a new name by pressing the **▲** or **▼** button. Press the **ENTER** button.
  - The selection bar is displayed around the name box.

To...	Then...
Select a letter, number or symbol	Press the <b>▲</b> or <b>▼</b> button
Move on the next letter	Press the <b>▶</b> button
Move back the previous letter	Press the <b>◀</b> button
Confirm the name	Press the <b>ENTER</b> button

➤ The following characters are available: Letters of the alphabet (A~Z) / Numbers (0~9) / Special characters (+, -, \*, /, space)

5. Repeat steps 3 to 4 for each channel to be assigned to a new name.
6. Press the **EXIT** button to exit.



## Fine Tuning Channel Reception

Use fine tuning to manually adjust a particular channel for optimal reception.

- Not available in DTV or external input mode.
- 1. Use the number buttons to directly select the channel that you want to fine tune.
- 2. Press the **MENU** button to display the menu. Press the **▲** or **▼** button to select "Channel", then press the **ENTER** button.
- 3. Press the **▲** or **▼** button to select "Fine Tune", then press the **ENTER** button.
- 4. Press the **◀** or **▶** button to adjust the fine tuning. Press the **ENTER** button.
- 5. Press the **EXIT** button to exit.
  - Fine tuned channels that have been saved are marked with an asterisk "\*" on the right-hand side of the channel banner. And the channel number turns red.
  - To reset the fine-tuning, select "Reset" by pressing the **▲** or **▼** button and then press the **ENTER** button.

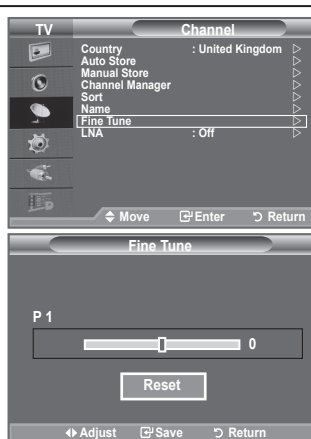

## LNA (Low Noise Amplifier)

If the TV is operating in a weak-signal area, the LNA function can improve the reception (a low-noise preamplifier boosts the incoming signal).

- Not available in DTV or external input mode.
- 1. Press the **MENU** button to display the menu. Press the **▲** or **▼** button to select "Channel", then press the **ENTER** button.
- 2. Press the **▲** or **▼** button to select "LNA", then press the **ENTER** button.
- 3. Press the **▲** or **▼** button to select "Off" or "On". Press the **ENTER** button.
- 4. Press the **EXIT** button to exit.





# Changing the Picture Standard

You can select the type of picture which best corresponds to your viewing requirements.

1. Press the **MENU** button to display the menu.  
Press the **ENTER** button, to select "Picture".
2. Press the **ENTER** button again, to select "Mode".
3. Press the **▲** or **▼** button to select the desired picture effect.  
Press the **ENTER** button.
4. Press the **EXIT** button to exit.

- ◆ **Dynamic:** Selects the picture for high-definition in a bright room.
- ◆ **Standard:** Selects the picture for optimum display in a normal environment.
- ◆ **Movie:** Selects the picture for comfortable display in a dark room.

➤ The Picture mode must be adjusted separately for each input source.

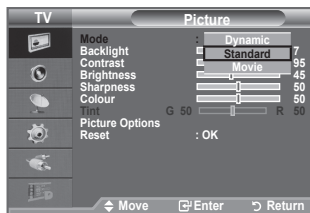
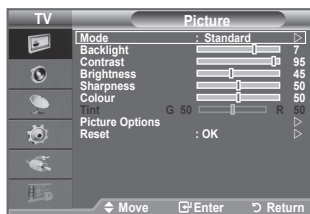

## Easy Setting

1. Press the **TOOLS** button on the remote control.
2. Press the **▲** or **▼** button to select "Picture Mode".
3. Press the **◀** or **▶** button to select the required option.
4. Press the **EXIT** or **TOOLS** button to exit.

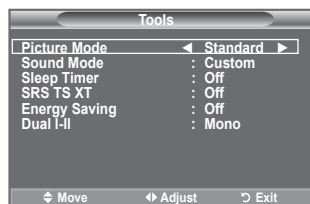

## Adjusting the Custom Picture

Your set has several settings which allow you to control picture quality.

1. To select the desired picture effect, follow the "Changing the Picture Standard" instructions number 1 to 3. (On page 15)
2. Press the ▲ or ▼ button to select a particular item. Press the **ENTER** button.
3. Press the ◀ or ▶ button to decrease or increase the value of a particular item. Press the **ENTER** button.
4. Press the **EXIT** button to exit.

- ◆ **Backlight:** Adjusts the screen brightness by adjusting the LCD backlight brightness. (0~10)
- ◆ **Contrast:** Adjusts the lightness and darkness between objects and the background.
- ◆ **Brightness:** Adjusts the brightness of the whole screen.
- ◆ **Sharpness:** Adjusts the outline of objects to either sharpen them or make them more dull.
- ◆ **Colour:** Adjusts the colours, making them lighter or darker.
- ◆ **Tint:** Adjusts the colour of objects, making them more red or green for a more natural look.

- The adjusted values are stored according to the selected Picture mode.
- In PC mode, you can only make changes to "Backlight", "Contrast" and "Brightness".
- In Analogue TV, Ext., AV modes of the PAL system, you cannot use the "Tint" Function.
- You can return to the factory defaults picture settings by selecting the "Reset". (Refer to "Resetting the Picture Settings to the Factory Defaults" on page 16)
- The energy consumed during use can be significantly reduced if the level of brightness of the picture is reduced, and that this will reduce the overall running cost.

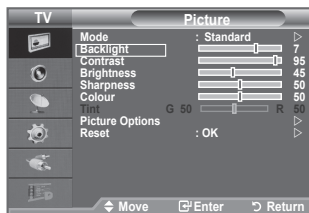

## Resetting the Picture Settings to the Factory Defaults

You can return to the factory defaults picture settings.

1. To select the desired picture effect, follow the "Changing the Picture Standard" instructions number 1 to 3 on page 15.
  2. Press the ▲ or ▼ button to select "Reset", then press the **ENTER** button.
  3. Press the ▲ or ▼ button to select "OK" or "Cancel". Press the **ENTER** button.
  4. Press the **EXIT** button to exit.
- The "Reset" will be set for each Picture mode.

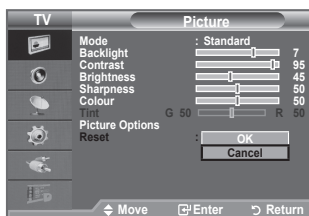

## Changing the Picture Options

1. Press the **MENU** button to display the menu.  
Press the **ENTER** button, to select "Picture".
2. Press the **▲** or **▼** button to select "Picture Options", then press the **ENTER** button.
3. Select the required option by pressing the **▲** or **▼** button, then press the **ENTER** button.
4. When you are satisfied with your setting, press the **ENTER** button.
5. Press the **EXIT** button to exit.
  - In PC mode, you can only make changes to the "Colour Tone" and "Size" from among the items in "Picture Options".

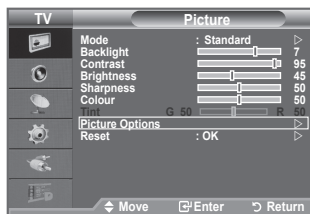



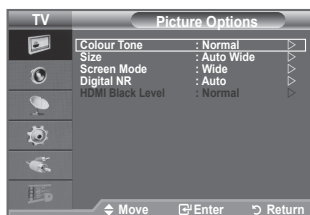

- ◆ **Colour Tone: Cool2/Cool1/Normal/Warm1/Warm2**  
You can select the most comfortable colour tone to your eyes.
  - The adjusted values are stored according to the selected Picture mode.



- "Warm1" or "Warm2" is only activated when the picture mode is "Movie".

- ◆ **Size: Auto Wide/Wide/16:9/Wide Zoom/Zoom/4:3/Just Scan**  
You can select the picture size which best corresponds to your viewing requirements.

- ◆ **Auto Wide:** Automatically adjusts the picture size to the "16:9" aspect ratio.
- ◆ **Wide:** Adjusts the picture size to 16:10 appropriate for DVDs or wide broadcasting.
- ◆ **16:9:** Adjusts the picture size to 16:9 appropriate for DVDs or wide broadcasting.
- ◆ **Wide Zoom:** Magnify the size of the picture more than 4:3.
- ◆ **Zoom:** Magnifies the 16:9 wide picture (in the vertical direction) to fit the screen size.
- ◆ **4:3:** This is the default setting for a video movie or normal broadcasting.
- ◆ **Just Scan:** Use the function to see the full image without any cutoff when HDMI (720p/1080i) or Component (1080i) signals are input.

- "Auto Wide" function is available only in "TV", "DTV", "Ext." and "AV" mode.
- In PC Mode, only "Wide" and "4:3" mode can be adjusted.
- Settings can be adjusted and stored for each external device you have connected to an input of the TV.
- Temporary image retention may occur when viewing a static image on the set for more than two hours.
- **Wide Zoom:** Move the screen up/down using the **▲** or **▼** button after selecting the  by pressing the **▶** or **ENTER** button.
- **Zoom:** Select  by pressing the **◀** or **▶** button.  
Use the **▲** or **▼** button to move the picture up and down. After selecting , use the **▲** or **▼** button to magnify or reduce the picture size in the vertical direction.
- **After selecting "Just Scan" in HDMI (1080i) or Component (1080i) mode:**  
Select  by pressing the **◀** or **▶** button. Use the **▲**, **▼**, **◀** or **▶** button to move the picture.  
**Reset:** Press the **◀** or **▶** button to select "Reset", then press the **ENTER** button.  
You can initialize the setting.

- ☞ You can select these options by simply pressing the **P.SIZE** button on the remote control.

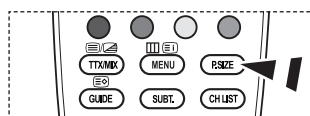

◆ **Screen Mode: Wide/16:9/Wide Zoom/Zoom/4:3**

When setting the picture size to "Auto Wide" in a 16:9 wide TV, you can determine the picture size you want to see the 4:3 WSS (Wide Screen Service) image or nothing. Each individual European country requires different picture size so this function is intended for users to select it.

- ◆ **Wide:** Sets the picture to 16:10 wide mode.
- ◆ **16:9:** Sets the picture to 16:9 wide mode.
- ◆ **Wide Zoom:** Magnify the size of the picture more than 4:3.
- ◆ **Zoom:** Magnify the size of the picture vertically on screen.
- ◆ **4:3:** Sets the picture to 4:3 normal mode.

- This function is available in "Auto Wide" mode.
- This function is not available in "Component" or "HDMI" mode.

◆ **Digital NR: Off/Low/Medium/High/Auto**

If the broadcast signal received by your TV is weak, you can activate the Digital Noise Reduction feature to help reduce any static and ghosting that may appear on the screen.

- When the signal is weak, select one of the other options until the best picture is displayed.

◆ **HDMI Black Level: Normal/Low**

You can select the black level on the screen to adjust the screen depth.

- This function is active only when the external input connects to HDMI(RGB signals).

# Sound Features

1. Press the **MENU** button to display the menu. Press the **▲** or **▼** button to select "Sound", then press the **ENTER** button.
2. Select the required option by pressing the **▲** or **▼** button, then press the **ENTER** button.
3. When you are satisfied with your setting, press the **ENTER** button.
4. Press the **EXIT** button to exit.

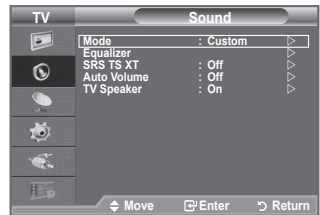

## ◆ Mode: Standard/Music/Movie/Speech/Custom

You can select the type of special sound effect to be used when watching a given broadcast.

### Easy Setting

1. Press the **TOOLS** button on the remote control.
2. Press the **▲** or **▼** button to select "Sound Mode".
3. Press the **◀** or **▶** button to select the desired sound mode.
4. Press the **EXIT** or **TOOLS** button to exit.

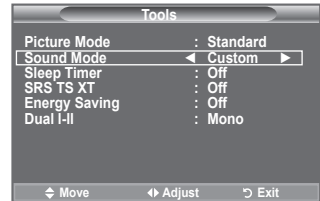

## ◆ Equalizer: Balance/100Hz/300Hz/1kHz/3kHz/10kHz

The sound settings can be adjusted to suit your personal preferences.

- If you make any changes to these settings, the sound mode is automatically switched to "Custom".

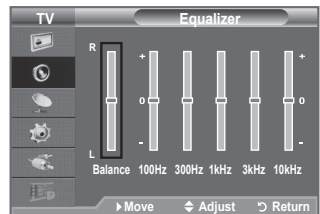



## ◆ SRS TS XT: Off/On

TruSurround XT is a patented SRS technology that solves the problem of playing 5.1 multichannel content over two speakers. TruSurround delivers a compelling, virtual surround sound experience through any two-speaker playback system, including internal television speakers. It is fully compatible with all multichannel formats.

### Easy Setting

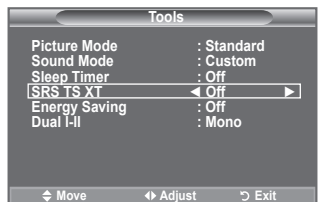
1. Press the **TOOLS** button on the remote control.
2. Press the **▲** or **▼** button to select "SRS TS XT".
3. Press the **◀** or **▶** button to select the "Off" or "On".
4. Press the **EXIT** or **TOOLS** button to exit.



TruSurround XT, SRS and  Symbol are trademarks of SRS Labs, Inc. TruSurround XT technology is incorporated under license from SRS Labs, Inc.

◆ **Auto Volume: Off/On**

Each broadcasting station has its own signal conditions, and so it is not easy to adjust the volume every time the channel is changed. This feature lets you automatically adjust the volume of the desired channel by lowering the sound output when the modulation signal is high or by raising the sound output when the modulation signal is low.

◆ **TV Speaker: Off/On**

If you want to hear the sound through separate speakers, cancel the internal amplifier.

- The ◀ +, ▶ - and MUTE buttons do not operate when the "TV Speaker" is set to "Off".
- When "TV Speaker" is set to "Off", the Sound menus cannot be adjusted.



Manufactured under license from Dolby Laboratories. Dolby and the double-D symbol are trademarks of Dolby Laboratories.

## Selecting the Sound Mode

You can set the sound mode in the "Tools" menu. When you set to "Dual I-II", the current sound mode is displayed on the screen.

1. Press the **TOOLS** button on the remote control.
2. Press the ▲ or ▼ button to select "Dual I-II".
3. Press the ◀ or ▶ button to select required option.
4. Press the **ENTER** button.

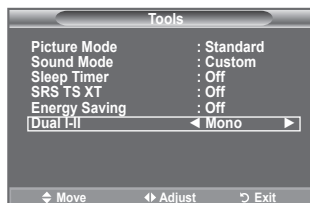

	Audio Type	Dual 1/2	Default
A2 Stereo	Mono	MONO	Automatic change
	Stereo	STEREO ↔ MONO	
	Dual	DUAL 1 ↔ DUAL 2	DUAL 1
NICAM Stereo	Mono	MONO	Automatic change
	Stereo	MONO ↔ STEREO	
	Dual	MONO ↔ DUAL 1 DUAL 2 ↔	DUAL 1

- If the stereo signal is weak and an automatic switching occurs, then switch to the Mono.
- This function is only activated in stereo sound signal. It is deactivated in mono sound signal.
- This function is only available in Analogue TV mode.

## Connecting Headphones (Sold separately)

You can connect a set of headphones to your set if you wish to watch a TV programme without disturbing the other people in the room.

- When you insert the head set jack into the corresponding port, you can operate only "Auto Volume" in Sound menu.
- Prolonged use of headphones at a high volume may damage your hearing.
- You will not receive sound from the speakers when you connect headphones to the system.
- The headphone volume and TV volume are adjusted differently.



## Setting and Displaying the Current Time

You can set the TV's clock so that the current time is displayed when you press the INFO button. You must also set the time if you wish to use the automatic On/Off timers.

1. Press the **MENU** button to display the menu.  
Press the **▲** or **▼** button to select "Setup", then press the **ENTER** button.
2. Press the **▲** or **▼** button to select "Time", then press the **ENTER** button.
3. Press the **ENTER** button to select "Clock Set".

To...	Press the...
Move to "Month", "Day", "Year", "Hour" or "Minute"	◀ or ▶ button.
Set the "Month", "Day", "Year", "Hour" or "Minute"	▲ or ▼ button.
Confirm the setting	<b>ENTER</b> button.

5. Press the **EXIT** button to exit.

- > If you disconnect the power cord, you have to set the clock again.
- > You can also set "Year", "Month", "Day", "Hour" and "Minute" by pressing the number buttons on the remote control.

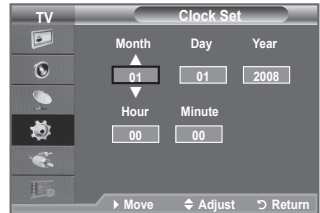

## Setting the Sleep Timer

You can select a time period of between 30 and 180 minutes after which the television automatically switches to standby mode.

1. Press the **MENU** button to display the menu.  
Press the **▲** or **▼** button to select "Setup", then press the **ENTER** button.
  2. Press the **▲** or **▼** button to select "Time", then press the **ENTER** button.
  3. Press the **▲** or **▼** button to select "Sleep Timer", then press the **ENTER** button.
  4. Press the **▲** or **▼** button repeatedly until the desired time appears (Off, 30, 60, 90, 120, 150, 180).  
Press the **ENTER** button.
  5. Press the **EXIT** button to exit.
- > The TV automatically switches to standby mode when the timer reaches 0.

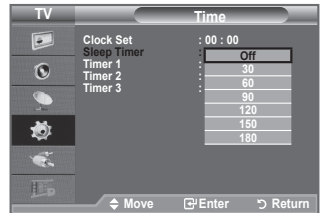
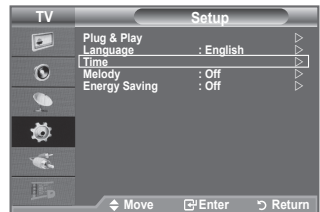

### Easy Setting

1. Press the **TOOLS** button on the remote control.
2. Press the **▲** or **▼** button to select "Sleep Timer".
3. Press the **◀** or **▶** button to select the minute.
4. Press the **EXIT** or **TOOLS** button to exit.

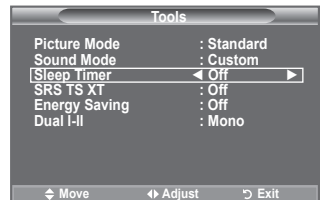

## Switching the Television On and Off Automatically

1. Press the **MENU** button to display the menu.  
Press the **▲** or **▼** button to select "Setup", then press the **ENTER** button.
  2. Press the **▲** or **▼** button to select "Time", then press the **ENTER** button.
  3. Press the **▲** or **▼** button to select "Timer 1", "Timer 2", "Timer 3", then press the **ENTER** button.  
Three different On/Off Timer Settings can be made.  
➤ You must set the clock first.
  4. Press the **◀** or **▶** button to select the required item below.  
Press the **▲** or **▼** button to adjust to the setting satisfied.
    - ◆ **On Time:** Select hour, minute, and "On"/"Off". (To activate timer with the setting satisfied, set to "On".)
    - ◆ **Off Time:** Select hour, minute, and "On"/"Off". (To activate timer with the setting satisfied, set to "On".)
    - ◆ **Repeat:** Select "Once", "Everyday", "Mon~Fri", "Mon~Sat", or "Sat~Sun".
    - ◆ **Volume:** Select the desired turn on volume level.
- You can set the hour and minute directly by pressing the number buttons on the remote control.
- **Auto Power Off**  
When you set the timer On, the TV will eventually turn off, if no controls are operated for 3 hours after the TV was turned on by timer. This function is only available in timer On mode and prevents overheating, which may occur if a TV is on for too long time.



## Choosing Your Language

When you start using your set for the first time, you must select the language which will be used for displaying menus and indications.

1. Press the **MENU** button to display the on-screen menu.  
Press the **▲** or **▼** button to select "Setup", then press the **ENTER** button.
2. Press the **▲** or **▼** button to select "Language", then press the **ENTER** button.
3. Select a particular language by pressing the **▲** or **▼** button repeatedly.  
Press the **ENTER** button.
4. Press the **EXIT** button to exit.





## Melody / Energy Saving

1. Press the **MENU** button to display the menu. Press the **▲** or **▼** button to select "Setup", then press the **ENTER** button.
2. Select the required option by pressing the **▲** or **▼** button, then press the **ENTER** button.
3. When you are satisfied with your setting, press the **ENTER** button.
4. Press the **EXIT** button to exit.



### ◆ **Melody: Off/Low/Medium/High**

The TV power on/off melody sound can be adjusted.

#### ➤ **The Melody does not play**

- When no sound is output from the TV because the **MUTE** button has been pressed.
- When no sound is output from the TV because the **⊖** (Volume) button has been pressed.
- When the TV is turned off by Sleep Timer function.

### ◆ **Energy Saving: Off/Low/Medium/High**

This feature adjusts the screen brightness depending on the surrounding lighting conditions.

- **Off**: Turns off the energy saving function.
- **Low**: Sets the TV to low energy saving mode.
- **Medium**: Sets the TV to medium energy saving mode.
- **High**: Sets the TV to high energy saving mode.

### **Easy Setting**

1. Press the **TOOLS** button on the remote control.
2. Press the **▲** or **▼** button to select "Energy Saving".
3. Press the **◀** or **▶** button to select the "Off", "Low", "Medium" or "High".
4. Press the **EXIT** or **TOOLS** button to exit.

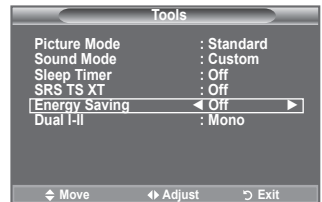

## Selecting the Source

You can select among external sources connected to your TV's input jacks.

1. Press the **MENU** button to display the menu.  
Press the **▲** or **▼** button to select "Input", then press the **ENTER** button.
2. Press the **ENTER** button again, to select "Source List".
  - Available signal sources: TV, Ext., AV, Component, PC, HDMI, DTV.
  - You can choose only those external devices that are connected to the TV.
3. Select the required device by pressing the **▲** or **▼** button. Press the **ENTER** button.

-  Press the **SOURCE** button on the remote control to toggle between all the available source.  
TV mode can be selected by pressing the **TV/DTV** button, number buttons(0~9), and the **PC** button on the remote control.

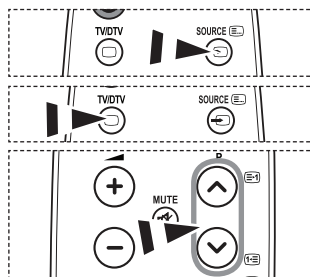
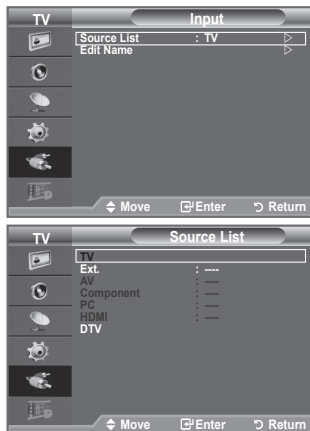

## Editing the Input Source Names

Name the device connected to the input jacks to make your input source selection easier.

1. Press the **MENU** button to display the menu.  
Press the **▲** or **▼** button to select "Input", then press the **ENTER** button.
2. Press the **▲** or **▼** button to select "Edit Name", then press the **ENTER** button.
3. Press the **▲** or **▼** button to select the device that you wish to edit.  
Press the **ENTER** button.
4. Press the **▲** or **▼** button to select the required device.  
Press the **ENTER** button.
5. Press the **EXIT** button to exit.



# Previewing the DTV Menu System

- ◆ The company does not guarantee the normal operation of the DTV menu for countries other than the supported countries (France, Germany, Italy, Netherlands, Spain, Switzerland, United Kingdom, Austria) because only these country standards are supported.

In addition, when the country of the broadcast stream differs from the country selected by the current user, the string appearing in the channel banner, Info, Guide, Channel Manager, etc. may not be displayed properly.

- ◆ Available in DTV mode. Preset to the DTV mode by using the **TV/DTV** button on your remote control. To help you navigate around the on-screen menu system and adjust the various settings available, refer to the following illustration.

Press the **MENU** button to display the menu.

Press the **▲** or **▼** button to select "Digital Menu", then press the **ENTER** button.

<b>Guide</b>	
— Now & Next Guide	
— Full Guide	
— Scheduled List	
— Default Guide	Now/Next, Full Guide
<b>Digital Channel</b>	
— Country	
— Auto Store	
— Manual Store	
— Edit Favourite Channels	
— Channel List	All, Favourites, Default
<b>Setup</b>	
— Menu Transparency	High, Medium, Low, Opaque
— Change PIN	
— Parental Lock	
— Subtitle	Off, On
— Subtitle Mode	Normal, Hard of hearing
— Audio Format	PCM, Dolby Digital
— Audio Description	Audio Description — Off, On Volume
— Digital Text	Disable, Enable
— Time Zone	
— Common Interface	Application Info, CI Menu
— System	Product Information Signal Information Software Upgrade Reset
<b>Language</b>	
— Audio Language	Primary Audio Language
— Subtitle Language	Secondary Audio Language
— Teletext Language	Primary Subtitle Language
— Preference	Secondary Subtitle Language Primary Teletext Language Secondary Teletext Language (depending on the country)

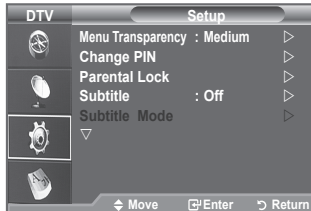
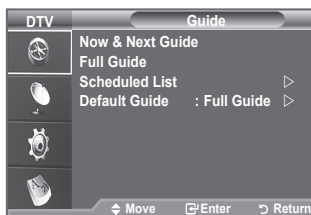

- The sub-items of the CI Menu may vary depending on the CAM model.

## Updating the Channel List Automatically

You can update the channel list when the broadcaster adds new Services or if you move the TV to a new location.

1. Press the **MENU** button to display the menu.  
Press the **▲** or **▼** button to select "Digital Menu", then press the **ENTER** button.
2. Press the **▲** or **▼** button to select "Digital Channel", then press the **ENTER** button.
3. Press the **ENTER** button again, to select "Country".
4. Select the appropriate country by pressing the **▲** or **▼** button.  
Press the **ENTER** button to confirm your choice.
  - Even though you have changed the country setting in this menu, the country setting for Analogue TV is not changed. (Refer to page 10)
5. Press the **▲** or **▼** button again, to select "Auto Store".  
Press the **ENTER** button.
  - When it has finished, the number of scanned services will be displayed.
  - The existing favourite channel list will not be deleted when the channel list is updated.
  - To stop the scan before it has finished, press the **ENTER** button with "STOP" selected.
6. Press the **EXIT** button to exit.
  - If the signal status is poor, the "No Service found! Check the aerial connection" message is displayed.

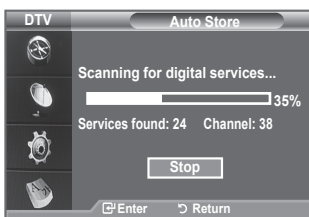

## Updating the Channel List Manually

You can specify the channel for a fast channel search.

1. Press the **MENU** button to display the menu.  
Press the **▲** or **▼** button to select "Digital Menu", then press the **ENTER** button.
2. Press the **▲** or **▼** button to select "Digital Channel", then press the **ENTER** button.
3. Press the **▲** or **▼** button to select "Manual Store", then press the **ENTER** button.
4. Press the **▲** or **▼** button to select the required option, then press the **ENTER** button.
  - - **Channel** : Channel "5" to "69" in sequence are displayed (depending on the country)
  - **Frequency** : The frequency available in the Channel group is displayed.
  - **Bandwidth** : The available bandwidths are 7 and 8 MHz.
  - Press the red button to start the scan for digital services.  
When it has finished, channels are updated in the channel list.
5. When it has finished, the number of scanned services will be displayed.
6. Press the **EXIT** button to exit.



## Editing Your Favourite Channels

You can edit your favourite channels using the four colour buttons.

1. Press the **MENU** button to display the menu.  
Press the **▲** or **▼** button to select "Digital Menu", then press the **ENTER** button.
2. Press the **▲** or **▼** button to select "Digital Channel", then press the **ENTER** button.
3. Press the **▲** or **▼** button to select "Edit Favourite Channels", then press the **ENTER** button.
4. Press the red button to display all currently stored channels.
5. Press the **▲** or **▼** button to select a channel you want.  
Press the **ENTER** button.
  - A "★" icon is shown next to the selected channel and the channel will be added to the favourite channel list.
  - • To undo, press the **ENTER** button again.
  - **Select All**: Select all channels currently displayed.
  - **Select None**: Deselect all selected channels.
  - **Preview**: Displays (a) currently selected channel(s).
  - The Favourite Channels settings have been completed.
6. Press the **EXIT** button to exit.

### ◆ Add

You can use this function when one or more favourite channels have been selected.

1. Press the **MENU** button to display the menu.  
Press the **▲** or **▼** button to select "Digital Menu", then press the **ENTER** button.
2. Press the **▲** or **▼** button to select "Digital Channel", then press the **ENTER** button.
3. Press the **▲** or **▼** button to select "Edit Favourite Channels", then press the **ENTER** button.
4. Press the red button in the "Edit Favourite Channels" menu.  
To add more channels, refer to the step 5 on the previous
5. If you want to check the channel to be stored, press **RETURN** button.  
Press the **EXIT** button to exit.
  - • To add all channels to the favourite channel list, press the red button.
  - To remove all channels, press the green button.
  - **Preview** : Displays (a) currently selected channel(s).
  - Press the **CH LIST** button to display the favourite channel manager.

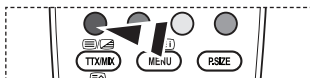

#### ◆ Renumber (depending on the country)

1. Press the **MENU** button to display the menu.  
Press the **▲** or **▼** button to select "Digital Menu", then press the **ENTER** button.
2. Press the **▲** or **▼** button to select "Digital Channel", then press the **ENTER** button.
3. Press the **▲** or **▼** button to select "Edit Favourite Channels", then press the **ENTER** button.
4. Select the required channel using the **▲** or **▼** button.
5. Press the green button.
  - The space for entering the number is a blank.
6. Enter the new channel number. Press **ENTER** button to store or **RETURN** button to cancel.
  - Press the **◀** button to delete an entered digit.
  - If you enter a number already assigned to another channel, the number is assigned to the selected channel and the previous number assigned to the selected channel is assigned to the other channel.  
That is, the two numbers are exchanged.
  - The Favourite Channels are automatically sorted in ascending order of channel numbers.
7. Press the **EXIT** button to exit.



#### ◆ Preview

1. In the "Edit Favourite Channels" menu, select the channel to be previewed by pressing the **▲** or **▼** button.
2. Press the yellow button.
  - The selected channel is displayed on the screen.

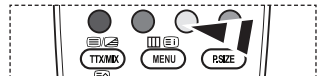

#### ◆ Delete

1. In the "Edit Favourite Channels" menu, select the channel to be deleted from the favourite channels list by pressing the **▲** or **▼** button.
2. Press the blue button.
  - The selected channel and number will be deleted.
  - To add a deleted channel back in to the favourite channel list, see "Add" on page 27.

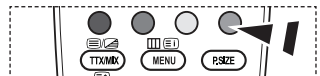

## Selecting Channel List

You can exclude the channels you have chosen from the channels you have scanned. When you scan through the stored channels, those you have chosen to skip are not displayed. All channels that you do not specifically choose to skip are displayed during scanning.

- Press the **MENU** button to display the menu.  
Press the **▲** or **▼** button to select "Digital Menu", then press the **ENTER** button.
- Press the **▲** or **▼** button to select "Digital Channel", then press the **ENTER** button.
- Press the **▲** or **▼** button to select "Channel List".  
Press the **ENTER** button.
- Press the **▲** or **▼** button to select "All", "Favourites" or "Default".  
Press the **ENTER** button.
- Press the yellow button to toggle between your favourite channels and all channels.
  - Your favourite channels are only displayed if they were previously set in the "Editing Your Favourite Channels" menu (refer to page 27).
- Press the red or green button to display the previous or next channel List page.
- Press the **▲** or **▼** button to select a channel to be tuned.  
Press the **ENTER** button.
  - The channel number, name and an icon are displayed in the top left corner while changing the channel. The channel number and name are displayed if the channel is one of the all channels, and a ★ icon if the channel is one of the favourite channels.
- Press the blue button to toggle between your "TV", "Radio", "Data/Other" and "All".
- Press the **CH LIST** button to exit from the channel List.

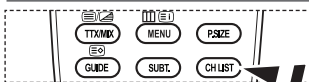

It can be displayed simply by pressing the **CH LIST** button.

## Displaying Programme Information

While viewing a channel, additional information about the current programme may be displayed.

- While viewing a programme, press the **INFO** button.
  - The programme information is displayed.
- To exit from banner information, press the **INFO** button.
  - The information is displayed:
    - Parental Rating
    - Video Type: SD, HD, Radio
    - Audio Type: Mono, Stereo, Dual, Dolby Digital
    - Existence of Teletext or DVB Subtitle
    - Audio Language

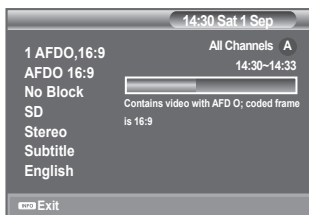

# Viewing the EPG (Electronic Programme Guide) Information

The EPG (Electronic Programme Guide) information is provided by the broadcasters. Programme entries may appear blank or out of date as a result of the information broadcast on a given channel. The display will dynamically update as soon as new information becomes available.

## ◆ Now & Next Guide

For the six channels indicated in the left-hand column, displays the Current programme and the Next programme information.

## ◆ Full Guide

Displays the programme information as time ordered One hour segments. Two hours of programme information is displayed which may be scrolled forwards or backwards in time.

1. Press the **MENU** button to display the menu.  
Press the **▲** or **▼** button to select "Digital Menu", then press the **ENTER** button.
2. Press the **ENTER** button, to select "Guide".
3. Press the **▲** or **▼** button to select "Now & Next Guide" or "Full Guide".  
Press the **ENTER** button.  
➤ You can also display the guide menu simply by pressing the **GUIDE** button.

To...	Then...
Watch a programme in the EPG list	<ul style="list-style-type: none"> <li>• Select a programme by pressing the <b>▲</b>, <b>▼</b>, <b>◀</b>, <b>▶</b> button.</li> <li>• Press the <b>ENTER</b> button.</li> </ul>
➤ If the next programme is selected, it is scheduled with the clock icon displayed. If the <b>ENTER</b> button is pressed again, the scheduling is cancelled with the clock icon gone. For details about scheduling programmes, refer to the next page.	
View programme information	<ul style="list-style-type: none"> <li>• Select a programme of your choice by pressing the <b>▲</b>, <b>▼</b>, <b>◀</b>, <b>▶</b> button.</li> <li>• Press the <b>INFO</b> button when the programme of your choice is highlighted.</li> </ul>
Toggle between the "Now & Next Guide" or "Full Guide"	• Press the red button repeatedly.
Display the "Favourites" and the "All Channels" list	• Press the green button repeatedly.
Scrolls backwards quickly (24 hours).	• Press the yellow button repeatedly.
Scrolls forward quickly (24 hours).	• Press the blue button repeatedly.
Exit the guide	• Press the <b>EXIT</b> button.

- The programme title is on the upper part of the screen center. Please click on **INFO** button for the detailed information. Channel Number, Running Time, Status Bar, Parental Level, Video Quality Information(HD/SD), Sound Modes, Subtitle or Teletext, Languages of Subtitle or Teletext, and brief summary of the highlighted programme are included on the detailed information. "... " will be appeared if the summary is long.
- Six channels are displayed. To scroll between channels, move to a channel using the **▲** or **▼** button. To display page by page, use the **P▲** or **P▼** button.

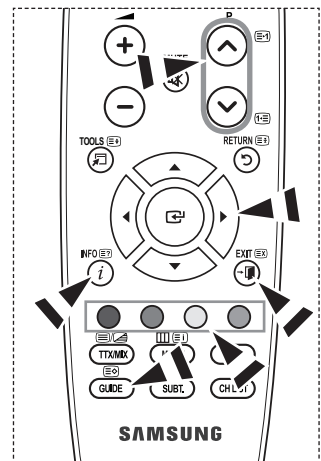



## Using the Scheduled List

If you make a scheduled viewing list of programs you may like to see, the channel will be automatically switched to the scheduled programme at the scheduled time even if you are watching another programme.

- Press the **MENU** button to display the menu.  
Press the **▲** or **▼** button to select "Digital Menu", then press the **ENTER** button.
- Press the **ENTER** button, to select "Guide".
- Press the **▲** or **▼** button to select "Scheduled List", then press the **ENTER** button.
- Press the red button.  
The channel will be switched to the scheduled programme.
- Press the **ENTER** button to select an item and adjust with the **▲** or **▼** button .
  - You can also set hour and minute by pressing the number buttons on the remote control.
    - **Channel:** Set the channel.
    - **Time:** Set the time.
    - **Date:** Set Year, Month and Day.
    - **Frequency:** Set the frequency.  
("Once", "Daily", or "Weekly")
- After setting the schedule, Press the red button.
- Press the **EXIT** button to exit.
  - • **Save:** Save the adjusted schedule.
  - **Cancel:** Cancel the adjusted schedule.
  - **Add Programme:** Add a new schedule.
  - **Edit:** Readjust the selected schedule.
  - **Delete:** Delete the selected schedule.

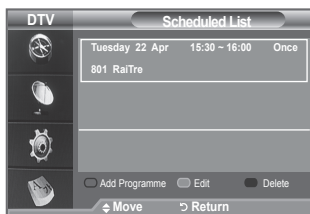
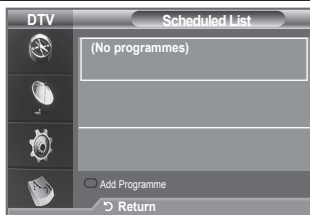

## Setting the Default Guide

You can preset the default guide style.

- Press the **MENU** button to display the menu.  
Press the **▲** or **▼** button to select "Digital Menu", then press the **ENTER** button.
- Press the **ENTER** button, to select "Guide".
- Press the **▲** or **▼** button to select "Default Guide", then press the **ENTER** button.
- Select "Now/Next" or "Full Guide" using the **▲** or **▼** button, and press the **ENTER** button.
- Press the **EXIT** button to exit.

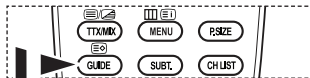

➤ You can select these options by simply pressing the **GUIDE** button on the remote control.

## Viewing All Channels and Favourite Channels

In the EPG menu, you can display all channels or favourite channels.

- Press the **MENU** button to display the menu.  
Press the **▲** or **▼** button to select "Digital Menu", then press the **ENTER** button.
- Press the **ENTER** button again, to select "Guide".
- Select the your required guide ("Now & Next Guide" or "Full Guide") by pressing the **▲** or **▼** button.
- Press the **ENTER** button.
- Press the green button.  
All the channel lists and the Favourite Channel lists will be toggled.
- Select a programme of your choice by pressing the **▲**, **▼**, **◀**, or **▶** button.
- Press the **INFO** button to display information about the highlighted programme.
- When the Edit Favourite Channels list has not been set up:
  - "The favourites list is empty. Would you like to choose your favourites now?" message is displayed.
  - Select "Yes".  
The "Edit Favourite Channels" menu is displayed.  
If you select "No", all channels will remain unchanged.
  - To edit the favourite channels, refer to page 27 for more details.
- Press the **EXIT** button to exit.
  - "All Channels" is the list of channels that have been scanned by the channel list update.  
All channels are displayed in the all channel mode.
  - "Favourites" (favourite channels) is the list of channels that has been set in the "Edit Favourite Channels" menu (refer to page 27).

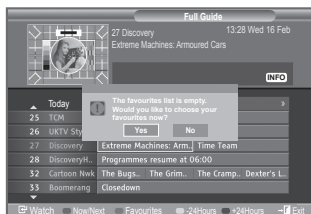

## Adjusting the Menu Transparency

You can set the Transparency of the menu.

- Press the **MENU** button to display the menu.  
Press the **▲** or **▼** button to select "Digital Menu", then press the **ENTER** button.
- Press the **▲** or **▼** button to select "Setup", then press the **ENTER** button.
- Press the **▲** or **▼** button to select "Menu Transparency" then press the **ENTER** button.
- Select the required option ("High", "Medium", "Low", or "Opaque") by pressing the **▲** or **▼** button, and press the **ENTER** button to change the setting.
- Press the **EXIT** button to exit.

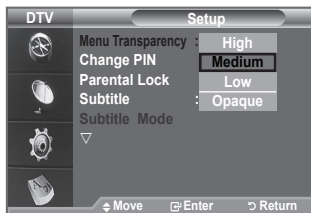

## Setting up the Parental Lock

This feature allows you to prevent unauthorized users, such as children, from watching unsuitable programmes by a 4-digit PIN (Personal Identification Number) code that is defined by the user. The on-screen menu will instruct you to assign a PIN code (you can change it later, if necessary).

1. Press the **MENU** button to display the menu.  
Press the **▲** or **▼** button to select "Digital Menu", then press the **ENTER** button.
2. Press the **▲** or **▼** button to select "Setup", then press the **ENTER** button.
3. Press the **▲** or **▼** button to select "Parental Lock", then press the **ENTER** button.
4. The "Enter PIN" is displayed.
5. Enter your current 4-digit PIN code by using the numeric buttons (0~9).
  - The default PIN code for a new TV set is 0000.
  - If you enter an invalid PIN code, the "Invalid PIN code. Please try again." message is displayed.
6. Press the **ENTER** button.
7. Press the **▲** or **▼** button to select the age rating you want to lock out.  
Press the **ENTER** button.

### ◆ Change PIN

1. Press the **MENU** button to display the menu.  
Press the **▲** or **▼** button to select "Digital Menu", then press the **ENTER** button.
2. Press the **▲** or **▼** button to select "Setup", then press the **ENTER** button.
3. Press the **▲** or **▼** button to select "Change PIN", then press the **ENTER** button.
  - The "Enter PIN" is displayed.
4. Enter your current 4-digit PIN code by using the numeric buttons (0~9).
  - The "Enter New PIN" is displayed.
5. Enter your new PIN code by using the numeric buttons (0~9)
  - The "Confirm New PIN" is displayed.
6. Re-enter your new PIN code to confirm by using the numeric buttons (0~9).
  - The Your PIN code has been changed successfully message is displayed.
7. Press the **ENTER** button.
8. Press the **EXIT** button to exit.
  - If you forget the PIN code, press the remote control buttons in the following sequence : which resets the PIN to 0-0-0-0: **POWER (Off), MUTE, 8, 2, 4, POWER (On)**.

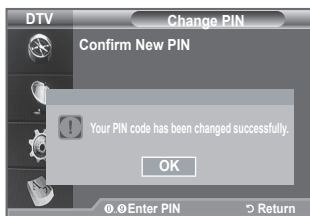
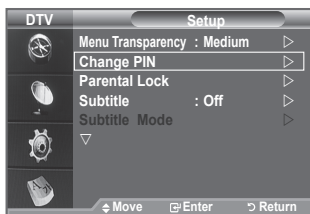
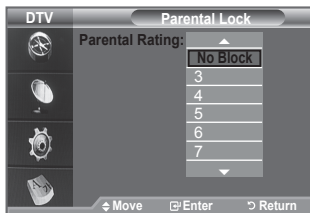
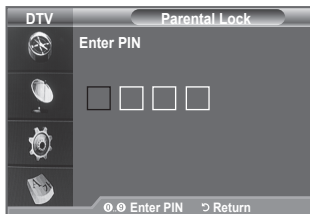
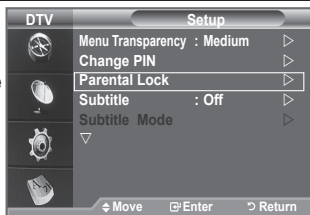

## Setting the Subtitle

You can activate and deactivate the subtitles.

1. Press the **MENU** button to display the menu.  
Press the **▲** or **▼** button to select "Digital Menu", then press the **ENTER** button.
2. Press the **▲** or **▼** button to select "Setup", then press the **ENTER** button.
3. Press the **▲** or **▼** button to select "Subtitle", then press the **ENTER** button.
4. Select "On" by pressing the **▲** or **▼** button. Press the **ENTER** button.
5. Press the **EXIT** button to exit.

 You can select these options simply by pressing the **SUBT.** button on the remote control.

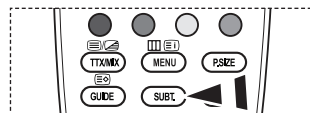
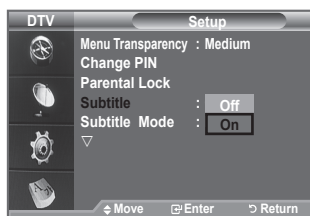

## Setting the Subtitle Mode

Use this menu to set the Subtitle Mode. "Normal" under the menu is the basic subtitle and "Hard of hearing" is the subtitle for a hearing-impaired person.

1. Press the **MENU** button to display the menu.  
Press the **▲** or **▼** button to select "Digital Menu", then press the **ENTER** button.
  2. Press the **▲** or **▼** button to select "Setup", then press the **ENTER** button.
  3. Press the **▲** or **▼** button to select "Subtitle Mode", then press the **ENTER** button.
  4. Press the **▲** or **▼** button to select "Normal" or "Hard of hearing". Press the **ENTER** button.
  5. Press the **EXIT** button to exit.
- If the programme you are watching does not support the "Hard of hearing" function, "Normal" automatically activates even though "Hard of hearing" mode is selected.

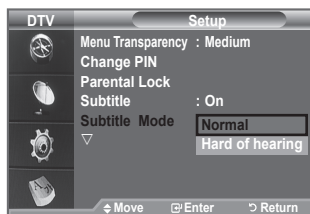

## Selecting the Audio Format

You can only hear Dolby Digital sound through the audio receiver connected through an optical cable. You can only hear PCM sound through the main speaker.

When sound is emitted from both the main speaker and the audio receiver, a sound echo may occur due to the decoding speed difference between the main speaker and the audio receiver. In this case, use the internal mute function.

1. Press the **MENU** button to display the menu.  
Press the **▲** or **▼** button to select "Digital Menu", then press the **ENTER** button.
2. Press the **▲** or **▼** button to select "Setup", then press the **ENTER** button.
3. Press the **▲** or **▼** button to select "Audio Format", then press the **ENTER** button.
4. Press the **▲** or **▼** button to select "PCM" or "Dolby Digital". Press the **ENTER** button.
5. Press the **EXIT** button to exit.

➤ The Audio Format appears according to the broadcasting signal. Dolby digital sound is only available when the TV is connected with an external speaker using an optical cable.

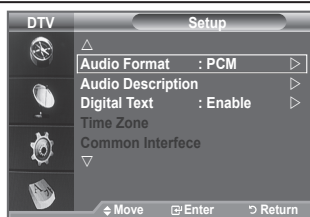

## Selecting the Audio Description

This is an auxiliary audio function that provides an additional audio track for visually challenged persons. This function handles the Audio Stream for the AD (Audio Description), when it is sent along with the Main audio from the broadcaster. Users can turn the Audio Description On or Off and control the volume.

1. Press the **MENU** button to display the menu.  
Press the **▲** or **▼** button to select "Digital Menu", then press the **ENTER** button.
2. Press the **▲** or **▼** button to select "Setup", then press the **ENTER** button.
3. Press the **▲** or **▼** button to select "Audio Description", then press the **ENTER** button.
4. Press the **▲** or **▼** button to select "On", then press the **ENTER** button.
5. Press the **▲** or **▼** button to select "Volume", then press the **ENTER** button.  
➤ "Volume" is active when "Audio Description" is set to "On".
6. Press the **◀** or **▶** button until you reach the optimal setting. Press the **ENTER** button.
7. Press the **EXIT** button to exit.

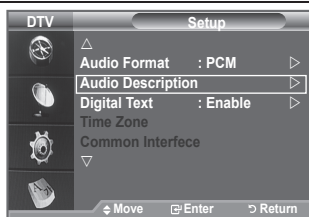

## Selecting the Digital Text (UK only)

If the programme is broadcast with digital text, this feature is enabled.

1. Press the **MENU** button to display the menu.  
Press the **▲** or **▼** button to select "Digital Menu", then press the **ENTER** button.
  2. Press the **▲** or **▼** button to select "Setup", then press the **ENTER** button.
  3. Press the **▲** or **▼** button to select "Digital Text", then press the **ENTER** button.
  4. Press the **▲** or **▼** button to select "Disable" or "Enable". Press the **ENTER** button.
  5. Press the **EXIT** button to exit.
- MHEG (Multimedia and Hypermedia Information Coding Experts Group) An International standard for data encoding systems used in multimedia and hypermedia. This is at a higher level than the MPEG system which includes data-linking hypermedia such as still images, character service, animation, graphic and video files as well as multimedia data. MHEG is user runtime interaction technology and is being applied to various fields including VOD (Video-On-Demand), ITV (Interactive TV), EC (Electronic Commerce), tele-education, tele-conferencing, digital libraries and network games.

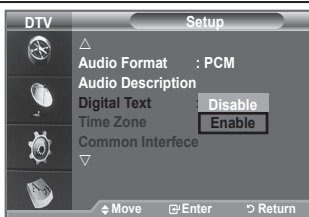

## Selecting the Time Zone (Spain only)

Select the local time zone.

1. Press the **MENU** button to display the menu.  
Press the **▲** or **▼** button to select "Digital Menu", then press the **ENTER** button.
2. Press the **▲** or **▼** button to select "Setup", then press the **ENTER** button.
3. Press the **▲** or **▼** button to select "Time Zone", then press the **ENTER** button.
4. Select the time zone where you locate by pressing the **▲** or **▼** button.  
Press the **ENTER** button.
  - The following options are available  
The Iberian Peninsula and Balearic Islands -  
Canary Islands
5. Press the **EXIT** button to exit.



## Viewing Product Information

You can view your product information. For service or repair, please contact a Samsung approved dealer.

1. Press the **MENU** button to display the menu.  
Press the **▲** or **▼** button to select "Digital Menu", then press the **ENTER** button.
2. Press the **▲** or **▼** button to select "Setup", then press the **ENTER** button.
3. Press the **▲** or **▼** button to select "System", then press the **ENTER** button.
4. Press the **ENTER** button again to select "Product Information".
  - The Product Information menu is selected.  
- Software Version, Firmware Version
5. Press the **EXIT** button to exit.

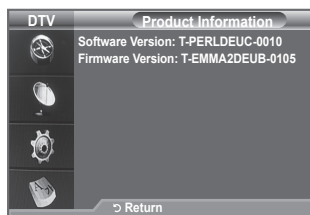

## Checking the Signal Information

You can get information about the signal status.

1. Press the **MENU** button to display the menu.  
Press the **▲** or **▼** button to select "Digital Menu", then press the **ENTER** button.
  2. Press the **▲** or **▼** button to select "Setup", then press the **ENTER** button.
  3. Press the **▲** or **▼** button to select "System", then press the **ENTER** button.
  4. Press the **▲** or **▼** button to select "Signal Information", then press the **ENTER** button.
  5. Press the **EXIT** button to exit.
- If the signal status is poor, the "No signal." message is displayed.

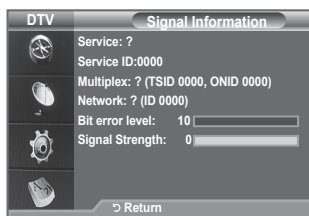

## Upgrading the Software

To keep your product up-to-date with new Digital Television features then software upgrades are periodically broadcast as part of the normal Television signal. It will automatically detect these signals and display the software upgrade banner. You are given the option to install the upgrade.

1. Press the **MENU** button to display the menu.  
Press the **▲** or **▼** button to select "Digital Menu", then press the **ENTER** button.
2. Press the **▲** or **▼** button to select "Setup", then press the **ENTER** button.
3. Press the **▲** or **▼** button to select "System", then press the **ENTER** button.
4. Press the **▲** or **▼** button to select "Software Upgrade", then press the **ENTER** button.
5. Press the **▲** or **▼** button to select "Software Information", "Manual Upgrade" or "Standby Mode upgrade".  
Press the **ENTER** button.

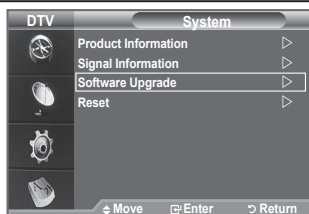

### ◆ Software Information

Press the **ENTER** button, then the current software version is shown. To display the software version information, press the **ENTER** button again.  
To switch to an alternative version, press the red button.  
Press the blue button to reset, activate the upgrade and restart.

### ◆ Manual Upgrade

Press the **ENTER** button to search for new software from the currently broadcasting channels.

### ◆ Standby Mode Upgrade: On / Off

Press the **ENTER** button. To continue software upgrade with master power on, Select On by pressing the **▲** or **▼** button. 45 minutes after entering standby mode, a manual upgrade is automatically conducted. Since the power of the unit is turned on internally, the screen may be on slightly for the LCD product. This phenomenon may continue for more than 1 hour until the software upgrade is completed.

6. Press the **EXIT** button to exit.

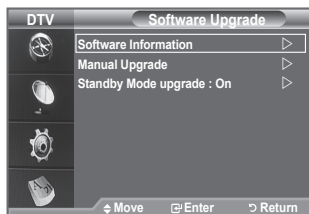

## Viewing Common Interface

This contains information on CAM inserted in the CI slot and displays it.

1. Press the **MENU** button to display the menu.  
Press the **▲** or **▼** button to select "Digital Menu", then press the **ENTER** button.
2. Press the **▲** or **▼** button to select "Setup", then press the **ENTER** button.
3. Press the **▲** or **▼** button to select "Common Interface", then press the **ENTER** button.
4. Press the **ENTER** button to display the information for your application.
5. Press the **EXIT** button to exit.
  - The Application Info inserting is about the CI CARD.  
You can install the CAM anytime whether the TV is ON or OFF.
    1. Purchase the CI CAM module by visiting your nearest dealer or by phone.
    2. Insert the CI CARD into the CAM in the direction of the arrow until it fits.
    3. Insert the CAM with the CI CARD installed into the common interface slot.  
(Insert the CAM in the direction of the arrow, right up to the end so that it is parallel with the slot.)
    4. Check if you can see a picture on a scrambled signal channel.

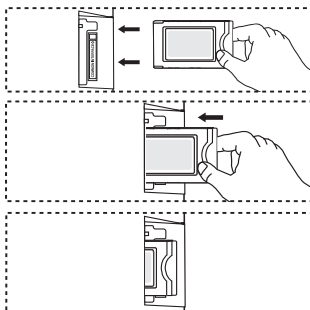
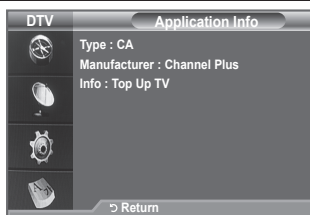

## Selecting the CI (Common Interface) Menu

This enables the user to select from the CAM-provided menu.

1. Press the **MENU** button to display the menu.  
Press the **▲** or **▼** button to select "Digital Menu", then press the **ENTER** button.
2. Press the **▲** or **▼** button to select "Setup", then press the **ENTER** button.
3. Press the **▲** or **▼** button to select "Common Interface", then press the **ENTER** button.
4. Select to "CI Menu" by pressing the **▲** or **▼** button, and press the **ENTER** button.
5. Select the required option by pressing the **▲** or **▼** button, and press the **ENTER** button.
6. Press the **EXIT** button to exit.
  - Select the CI Menu based on the menu PC Card.

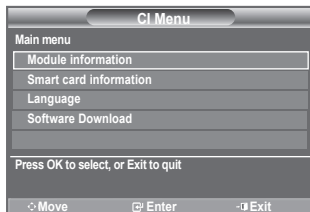



## Resetting

You can reset the values stored to the factory default values.

- The Reset operation deletes all channel information and user preferences returning all values to their default factory state.
- 1. Press the **MENU** button to display the menu. Press the **▲** or **▼** button to select "Digital Menu", then press the **ENTER** button.
- 2. Press the **▲** or **▼** button to select "Setup", then press the **ENTER** button.
- 3. Press the **▲** or **▼** button to select "System", then press the **ENTER** button.
- 4. Press the **▲** or **▼** button to select "Reset", then press the **ENTER** button.
- 5. The "Enter PIN" screen will appear.
- 6. Enter your current 4-digit PIN code by using the numeric buttons (0~9).
  - The warning message is displayed. All values will be reset by pressing the coloured buttons (red, green, yellow, and blue) in turn.
- 7. Press the **EXIT** button to exit.

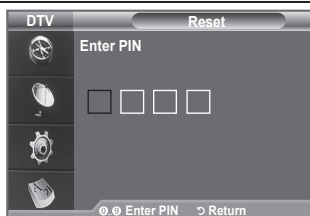

## Selecting the Preferred Language (Subtitle, Audio or Teletext)

You can change the default value for subtitle, audio teletext languages.

Displays the language information for the incoming stream.

1. Press the **MENU** button to display the menu. Press the **▲** or **▼** button to select "Digital Menu", then press the **ENTER** button.
2. Press the **▲** or **▼** button to select "Language", then press the **ENTER** button.
3. Press the **▲** or **▼** button to select "Audio Language", "Subtitle Language" or "Teletext Language". Press the **ENTER** button.
4. Select a particular language by pressing the **▲** or **▼** button repeatedly. Press the **ENTER** button.
  - English is the default in cases where the selected language is unavailable in the broadcast.
5. Press the **EXIT** button to exit.
  - While viewing a programme, the subtitle can be selected. While viewing a programme, audio languages can be selected.

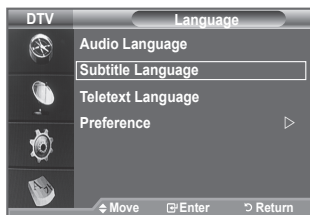

## Preference

This menu consists of 6 sub-menus:

**Primary Audio Language, Secondary Audio Language, Primary Subtitle Language, Secondary Subtitle Language, Primary Teletext Language, Secondary Teletext Language.**

Using this feature, users can select one of the languages.

The language selected here is the default when the user selects a channel.

- ◆ Press the ▲ or ▼ button to select required menu (Primary Audio Language, Secondary Audio Language, Primary Subtitle Language, Secondary Subtitle Language, Primary Teletext Language, Secondary Teletext Language), then press the **ENTER** button. The options of the selected menu are displayed.
- ◆ Select the appropriate language by pressing the ▲ or ▼ button. Press the **ENTER** button to confirm your choice.
- If you change the language setting, the Subtitle Language, Audio Language, and the Teletext Language of the Language menu (refer to page 39) are automatically changed to the selected language.
- The Subtitle Language, Audio Language, and the Teletext Language of the Language menu show a list of languages supported by the current channel and the selection is highlighted. If you change this language setting, the new selection is only valid for the current channel. The changed setting does not change the setting of the Primary Subtitle Language, Primary Audio Language, or the Primary Teletext Language of the Preference menu.

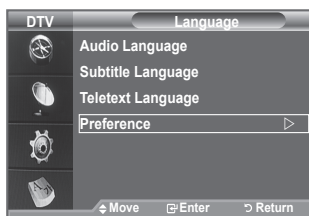

# Setting up Your PC Software (Based on Windows XP)

The Windows display-settings for a typical computer are shown below. The actual screens on your PC may be different depending upon your particular version of Windows and your particular video card. Even if your actual screens look different, the same, basic set-up information will apply in almost all cases. (If not, contact your computer manufacturer or Samsung Dealer.)

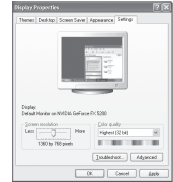

1. First, click on "Control Panel" on the Windows start menu.
2. When the control panel window appears, click on "Appearance and Themes" and a display dialog-box will appear.
3. When the control panel window appears, click on "Display" and a display dialog-box will appear.
4. Navigate to the "Settings" tab on the display dialog-box.  
The correct size setting (resolution): Optimum- 1680 X 1050 pixels  
If a vertical-frequency option exists on your display settings dialog box, the correct value is "60" or "60 Hz". Otherwise, just click "OK" and exit the dialog box.

## Display Modes

Both screen position and size will vary depending on the type of PC monitor and its resolution. The resolutions in the table are recommended.

### > D-Sub Input

Mode	Resolution	Horizontal Frequency (kHz)	Vertical Frequency (Hz)	Pixel Clock Frequency (MHz)	Sync Polarity (H/V)
IBM	640 x 350	31.469	70.086	25.175	+/-
	720 x 400	31.469	70.087	28.322	-/+
	640 x 480	31.469	59.940	25.175	-/-
	640 x 480	37.861	72.809	31.500	-/-
	640 x 480	37.500	75.000	31.500	-/-
VESA	800 x 600	37.879	60.317	40.000	+/+
	800 x 600	48.077	72.188	50.000	+/+
	800 x 600	46.875	75.000	49.500	+/+
	1024 x 768	48.363	60.004	65.000	-/-
	1024 x 768	56.476	70.069	75.000	-/-
	1024 x 768	60.023	75.029	78.750	+/+
	1280 x 1024	63.981	60.020	108.000	+/+
	1280 x 1024	79.976	75.025	135.000	+/+
	1360 x 768	47.712	60.015	85.500	+/+
	1680 x 1050RB	64.674	59.883	119.000	+/-

### > HDMI/DVI Input

Mode	Resolution	Horizontal Frequency (kHz)	Vertical Frequency (Hz)	Pixel Clock Frequency (MHz)	Sync Polarity (H/V)
VESA	640 x 480	31.469	59.940	25.175	-/-
	800 x 600	37.879	60.317	40.000	+/+
	1024 x 768	48.363	60.004	65.000	-/-
	1280 x 1024	63.981	60.020	108.000	+/+
	1360 x 768	47.712	60.015	85.500	+/+
	1680 x 1050RB	64.674	59.883	119.000	+/-

- When using an HDMI/DVI cable connection, you must use the HDMI IN jack.
- The interlace mode is not supported.
- The set might operate abnormally if a non-standard video format is selected.
- Separate and Composite modes are supported. SOG is not supported.

# Setting up the TV with your PC

➤ Preset: Press the **SOURCE** button to select PC mode.

1. Press the **MENU** button to display the menu.  
Press the **ENTER** button, to select "Picture".
2. Select the required option by pressing the **▲** or **▼** button, then press the **ENTER** button.
3. When you are satisfied with your setting, press the **ENTER** button.
4. Press the **EXIT** button to exit.

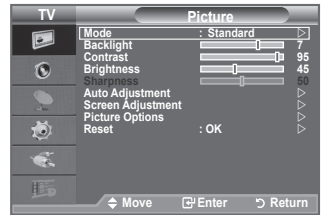

## ◆ Auto Adjustment

Auto adjustment allows the PC screen of set to self-adjust to the incoming PC video signal. The values of fine, coarse and position are adjusted automatically.

### Easy Setting

1. Press the **TOOLS** button on the remote control.
2. Press the **▲** or **▼** button to select "Auto Adjustment", then press the **ENTER** button.

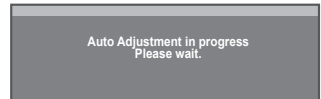

## ◆ Screen Adjustment: Coarse/Fine

The purpose of picture quality adjustment is to remove or reduce picture noise. If the noise is not removed by Fine-tuning alone, then adjust the frequency as best as possible (coarse) and Fine-tune again. After the noise has been reduced, re-adjust the picture so that it is aligned on the center of screen.

Press the **▲** or **▼** button to select "Coarse" or "Fine", then press the **ENTER** button.

Press the **◀** or **▶** button to adjust the screen quality.

Press the **ENTER** button.

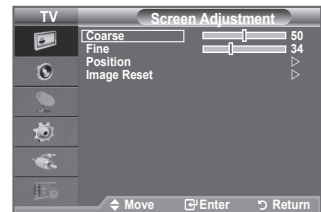

### Position

Adjust the PC's screen positioning if it does not fit the TV screen.

Press the **▲** or **▼** button to adjusting the Vertical-Position.

Press the **◀** or **▶** button to adjust the Horizontal-Position.

Press the **ENTER** button.

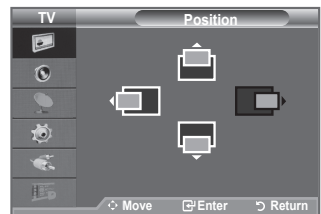

### Image Reset



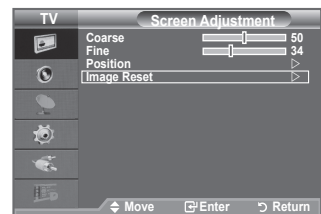









You can replace all image settings with the factory default values.



## Teletext Feature

Most television stations provide written information services via Teletext. The index page of the teletext service gives you information on how to use the service. In addition, you can select various options to suit your requirements by using the remote control buttons.

➤ For teletext information to be displayed correctly, channel reception must be stable. Otherwise, information may be missing or some pages may not be displayed.

- 1  (exit)  
Exit from the teletext display
- 2  (size)  
Press to display the double-size letters in the upper half of the screen. For lower half of the screen, press it again. To display normal screen, press it once again.
- 3  (reveal)  
Used to display the hidden text (answers to quiz games, for example). To display normal screen, press it again.
- 4  (teletext on/mix)  
Press to activate teletext mode after selecting the channel providing the teletext service. Press it twice to overlap the teletext with the current broadcasting screen.
- 5  (store)  
Used to store the teletext pages.
- 6  (mode)  
Press to select the teletext mode (LIST/FLOF). If you press it in the LIST mode, it switches into the List save mode. In the List save mode, you can save teletext page into list using the  (store) button.
- 7  (sub-page)  
Used to display the available sub-page.
- 8  (page up)  
Used to display the next teletext page.
- 9  (page down)  
Used to display the previous teletext page.
- 10  (hold)  
Used to hold the display on a given page if the selected page is linked with several secondary pages which follow on automatically. To resume, press it again.
- 11  (cancel)  
Used to display the broadcast when searching for a page.
- 12 **Colour buttons (red/green/yellow/blue)**  
If the FASTEXT system is used by a broadcasting company, the different topics covered on a teletext page are colour-coded and can be selected by pressing the coloured buttons. Press one of them corresponding to the required. The page is displayed with other coloured information that can be selected in the same way. To display the previous or next page, press the corresponding coloured button.
- 13  (index)  
Used to display the index (contents) page at any time while you are viewing teletext.

➤ You can change teletext pages by pressing the numeric buttons on the remote control.

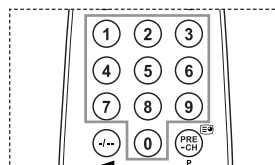
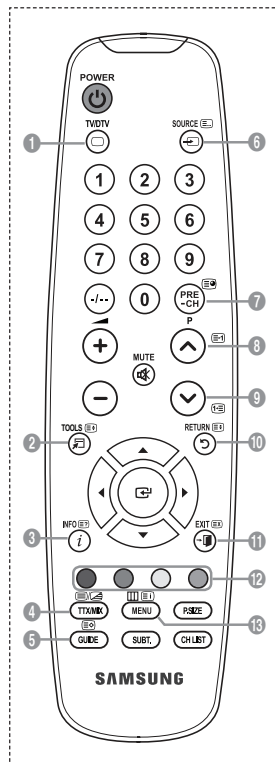

The teletext pages are organized according to six categories:

Part	Contents
A	Selected page number.
B	Broadcasting station identity.
C	Current page number or search status.
D	Date and time.
E	Text.
F	Status information. FASTEXT information.

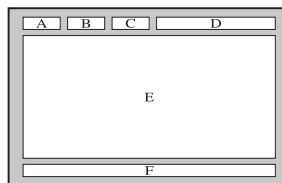

- Teletext information is often divided between several pages displayed in sequence, which can be accessed by:
  - ◆ Entering the page number
  - ◆ Selecting a title in a list
  - ◆ Selecting a coloured heading (FASTEXT system)
- Press the TV/DTV button to exit from the teletext display.

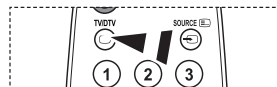

## Using the Anti-Theft KENSINGTON LOCK (depending on the model)

The Kensington Lock is a device used to physically fix the system when using it in a public place. The appearance and locking method may differ from the illustration depending on the manufacturer. Refer to the manual provided with the Kensington Lock for proper use. The locking device has to be purchased separately.

1. Insert the locking device into the Kensington slot on the LCD TV (Figure 1), and turn it in the locking direction (Figure 2).
  2. Connect the Kensington Lock cable.
  3. Fix the Kensington Lock to a desk or a heavy stationary object.
- The location of the Kensington Lock may be different depending on its model.

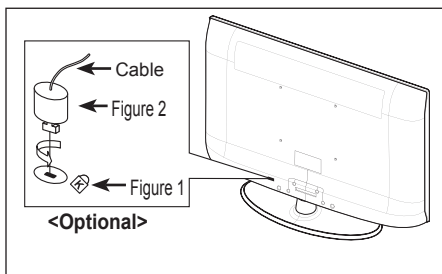

## Securing the TV to the Wall



**Caution:** Pulling, pushing, or climbing on the TV may cause the TV to fall. In particular, ensure your children do not hang over or destabilize the TV; doing so may cause the TV to tip over, causing serious injuries or death. Follow all safety precautions provided on the included Safety Flyer. For added stability, install the anti-fall device for safety purposes, as follows.

### To avoid the TV from falling:

1. Put the screws into the clamps and firmly fasten them onto the wall. Confirm that the screws have been firmly installed onto the wall.
  - You may need additional material such as an anchor depending on the type of wall.
  - Since the necessary clamps, screws, and string are not supplied, please purchase these additionally.

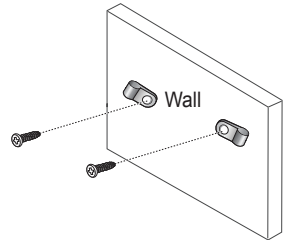

2. Remove the screws from the center back of the TV, put the screws into the clamps, and then fasten the screws onto the TV again.
  - Screws may not be supplied with the product. In this case, please purchase the screws of the following specifications.  
Screw Specifications
    - For a 17 ~ 29 Inch LCD TV: M4 X 15
    - For a 32 ~ 40 Inch LCD TV: M6 X 15

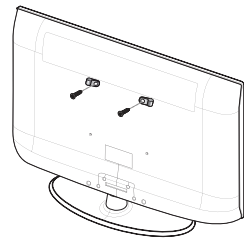

3. Connect the clamps fixed onto the TV and the clamps fixed onto the wall with a strong string and then tie the string tightly.
  - Install the TV near to the wall so that it does not fall backwards.
  - It is safe to connect the string so that the clamps fixed on the wall are equal to or lower than the clamps fixed on the TV.
  - Untie the string before moving the TV.

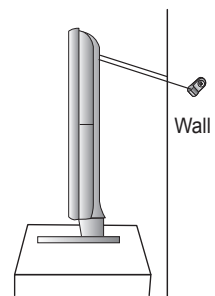

4. Verify all connections are properly secured. Periodically check connections for any sign of fatigue for failure. If you have any doubt about the security of your connections, contact a professional installer.

## Troubleshooting: Before Contacting Service Personnel

No sound or picture.	<ul style="list-style-type: none"> <li>• Check that the mains lead has been connected to a wall socket.</li> <li>• Check that you have pressed the <b>⏻</b> button on your set.</li> <li>• Check the picture contrast and brightness settings.</li> <li>• Check the volume.</li> </ul>
Normal picture but no sound.	<ul style="list-style-type: none"> <li>• Check the volume.</li> <li>• Check whether the <b>MUTE</b>  button has been pressed on the remote control.</li> <li>• Check if "TV Speaker" is on.</li> </ul>
Screen is black and power indicator light blinks steadily.	<ul style="list-style-type: none"> <li>• On your computer check; Power, Signal Cable.</li> <li>• The TV is using its power management system.</li> <li>• Move the computer's mouse or press any key on the keyboard.</li> </ul>
No picture or black and white picture.	<ul style="list-style-type: none"> <li>• Adjust the colour settings.</li> <li>• Check that the broadcast system selected is correct.</li> </ul>
Sound and picture interference.	<ul style="list-style-type: none"> <li>• Try to identify the electrical appliance that is affecting the set and move it further away.</li> <li>• Plug your set into a different mains socket.</li> </ul>
Blurred or snowy picture, distorted sound.	<ul style="list-style-type: none"> <li>• Check the direction, location and connections of your aerial. This interference is often due to the use of an indoor aerial.</li> </ul>
Remote control malfunctions.	<ul style="list-style-type: none"> <li>• Replace the remote control batteries.</li> <li>• Clean the upper edge of the remote control (transmission window).</li> <li>• Check the battery terminals.</li> </ul>
'Check signal cable.' message is displayed.	<ul style="list-style-type: none"> <li>• Check that the signal cable is firmly connected to the PC or video sources.</li> <li>• Check that the PC or video sources are turned on.</li> </ul>
On PC mode, 'Mode Not Supported' message is displayed.	<ul style="list-style-type: none"> <li>• Check the maximum resolution and the frequency of the video adaptor.</li> <li>• Compare these values with the data in the Display Modes.</li> </ul>
The damaged picture appears in the corner of the screen.	If "Just Scan" is selected in some external devices, the damaged picture may appear in the corner of the screen. This symptom is caused by external devices, not TV.
The 'Resets all settings to the default values' message appears.	This appears when you press and hold the <b>EXIT</b> button for a while. The product settings are reset to the factory defaults.
You may see small particles if you look closely at the edge of the bezel surrounding the TV screen.	This is part of the product's design and is not a defect.

The TFT LCD panel uses a panel consisting of sub pixels (5 292 000) which require sophisticated technology to produce. However, there may be few bright or dark pixels on the screen. These pixels will have no impact on the performance of the product.



## Technical and Environmental Specifications

<b>Model Name</b>	<b>LE22A455 / LE22A457</b>
<b>Screen Size (Diagonal)</b>	22 inch
<b>PC Resolution</b>	1680 x 1050 @ 60 Hz
<b>Sound Output</b>	3W x 2
<b>Dimensions (WxDxH)</b>	
Body	558 X 67 X 404 mm
With stand	558 X 216 X 453 mm
<b>Weight</b>	
With stand	7 kg
<b>Environmental Considerations</b>	
Operating Temperature	10 °C to 40 °C (50 °F to 104 °F)
Operating Humidity	10 % to 80 %, non-condensing
Storage Temperature	-20 °C to 45 °C (-4 °F to 113 °F)
Storage Humidity	5 % to 95 %, non-condensing
<b>Stand Swivel</b> (Left / Right)	0°

- Design and specifications are subject to change without prior notice.
- This device is a Class B digital apparatus.
- For the power supply and Power Consumption, refer to the label attached to the product.